

Operation and Service Manual

# AC Resistance Bridge

---

**SIM921**



Stanford Research Systems

---

Revision 2.3 • September 12, 2011

---

## Certification

Stanford Research Systems certifies that this product met its published specifications at the time of shipment.

## Warranty

This Stanford Research Systems product is warranted against defects in materials and workmanship for a period of one (1) year from the date of shipment.

## Service

For warranty service or repair, this product must be returned to a Stanford Research Systems authorized service facility. Contact Stanford Research Systems or an authorized representative before returning this product for repair.

Information in this document is subject to change without notice.

Copyright © Stanford Research Systems, Inc., 2003 – 2011. All rights reserved.

Stanford Research Systems, Inc.  
1290–D Reamwood Avenue  
Sunnyvale, CA 94089 USA  
Phone: (408) 744-9040 • Fax: (408) 744-9049  
**www.thinkSRS.com • e-mail: info@thinkSRS.com**

Printed in U.S.A.

Document number 9-01555-903



*SIM921 AC Resistance Bridge*

---

# Contents

---

<b>General Information</b>	<b>iii</b>
Service . . . . .	iii
Symbols . . . . .	iv
Notation . . . . .	v
Specifications . . . . .	vi
<b>1 Getting Started</b>	<b>1 – 1</b>
1.1 Introduction to the Instrument . . . . .	1–2
1.2 Front-Panel Operation . . . . .	1–3
1.3 Sensor Interface . . . . .	1–8
1.4 SIM Interface . . . . .	1–11
<b>2 Remote Operation</b>	<b>2 – 1</b>
2.1 Index of Commands . . . . .	2–2
2.2 Alphabetic List of Commands . . . . .	2–4
2.3 Introduction . . . . .	2–7
2.4 Commands . . . . .	2–8
2.5 Status Model . . . . .	2–26
<b>3 Circuitry</b>	<b>3 – 1</b>
3.1 Circuit Discussion . . . . .	3–2
3.2 Parts Lists . . . . .	3–6
3.3 Schematic Diagrams . . . . .	3–8



---

## General Information

---

The SIM921 AC Resistance Bridge, part of Stanford Research Systems' Small Instrumentation Modules family, is a precision, high-sensitivity instrument designed for ultra-low power resistance measurements, typically for cryogenic thermometry.

## Service

Do not install substitute parts or perform any unauthorized modifications to this instrument.

The SIM921 is a double-wide module designed to be used inside the SIM900 Mainframe. Do not turn on the power until the module is completely inserted into the mainframe and locked in place.

### Symbols you may Find on SRS Products

Symbol	Description
	Alternating current
	Caution - risk of electric shock
	Frame or chassis terminal
	Caution - refer to accompanying documents
	Earth (ground) terminal
	Battery
	Fuse
	On (supply)
	Off (supply)

## Notation



### WARNING

The following notation will be used throughout this manual.

A warning means that injury or death is possible if the instructions are not obeyed.



### CAUTION

A caution means that damage to the instrument or other equipment is possible.

Typesetting conventions used in this manual are:

- Front-panel buttons are set as [Button];  
[Adjust ▲▼] is shorthand for “[Adjust ▲] & [Adjust ▼]”.
- Front-panel indicators are set as *Overload*.
- Remote command names are set as \*IDN?.
- Literal text other than command names is set as OFF.

Remote command examples will all be set in monospaced font. In these examples, data sent by the host computer to the SIM921 are set as *straight teletype font*, while responses received by the host computer from the SIM921 are set as *slanted teletype font*.

## Specifications

### Performance Characteristics

Measurement	Measurement type	4 wire AC bridge
	Number of inputs	1
	Resistance range	1 m $\Omega$ to 100 M $\Omega$
	Time constant	0.3 s to 300 s, or sync. only
	Reading rate	2 updates/s
	Demodulator resolution	32-bit
	Resolution	see table
	Accuracy (% reading + % range)	
	2 $\Omega$ to 200 k $\Omega$ , $\geq 30 \mu\text{V}$ , $\geq 3 \text{nA}$	$\pm(0.05 \% + 0.05 \%)$
	200 m $\Omega$ to 2 M $\Omega$ , $\geq 100 \text{pA}$	$\pm(0.15 \% + 0.15 \%)$
	Stability	
	after autocal	$(\pm 0.001 \% \text{ of reading})/^{\circ}\text{C}$
	without autocal	$(\pm 0.02 \% \text{ of reading})/^{\circ}\text{C}$
	Max. lead resistance	100 $\Omega$ + 25 % range
Input impedance	> 10 G $\Omega$ , typical	
Source	Type	Sinusoid, constant $I, V$ , or $P$
	Frequency	2 Hz to 60 Hz, continuously adjustable
	Excitation	3 $\mu\text{V}$ to 30 mV, 10 mA max.
	Max. DC current	< 3 $\mu\text{V}$ /range
Thermometry	Sensors supported	All resistive sensors (– and + tempco)
	Temperature units	mK, K
	Low temperature	~50 mK, sensor dependent
	Sensor cal. curves	3 curves of 200 points each
Analog Output	Range	$\pm 10 \text{V}$
	Resolution	300 $\mu\text{V}$
	Accuracy	1 mV
Operating	Temperature	0 $^{\circ}\text{C}$ to 40 $^{\circ}\text{C}$ , non-condensing
	Interface	Serial via SIM interface
	Connectors	
	Sensor	DB–9 (female)
	Analog out	BNC (front)
	SIM	DB–15 (male) SIM Interface
	Power	$\pm 15 \text{VDC}$ , +5 VDC
Supply current	150 mA ( $\pm 15 \text{V}$ ), 250 mA (+5 V)	



## Resolution

Resolution is given in the table below. Upper values give excitation current, while lower values are typical RMS resistance noise measured at 50 % full scale on a room-temperature resistor with a 3 second output time constant.

Range	Excitation								
	30 mV	10 mV	3 mV	1 mV	300 $\mu$ V	100 $\mu$ V	30 $\mu$ V	10 $\mu$ V	3 $\mu$ V
20 m $\Omega$	N/A	N/A	N/A	N/A	N/A	10 mA	3 mA	1 mA	300 $\mu$ A
						44 $\mu\Omega$	130 $\mu\Omega$	510 $\mu\Omega$	1.5 m $\Omega$
200 m $\Omega$	N/A	N/A	N/A	10 mA	3 mA	1 mA	300 $\mu$ A	100 $\mu$ A	30 $\mu$ A
				8.9 $\mu\Omega$	12 $\mu\Omega$	32 $\mu\Omega$	120 $\mu\Omega$	590 $\mu\Omega$	1.4 m $\Omega$
2 $\Omega$	N/A	10 mA	3 mA	1 mA	300 $\mu$ A	100 $\mu$ A	30 $\mu$ A	10 $\mu$ A	3 $\mu$ A
		4.3 $\mu\Omega$	5.5 $\mu\Omega$	7.9 $\mu\Omega$	23 $\mu\Omega$	70 $\mu\Omega$	220 $\mu\Omega$	730 $\mu\Omega$	1.8 m $\Omega$
20 $\Omega$	3 mA	1 mA	300 $\mu$ A	100 $\mu$ A	30 $\mu$ A	10 $\mu$ A	3 $\mu$ A	1 $\mu$ A	300 nA
	20 $\mu\Omega$	21 $\mu\Omega$	33 $\mu\Omega$	41 $\mu\Omega$	100 $\mu\Omega$	390 $\mu\Omega$	1.7 m $\Omega$	4.1 m $\Omega$	10 m $\Omega$
200 $\Omega$	300 $\mu$ A	100 $\mu$ A	30 $\mu$ A	10 $\mu$ A	3 $\mu$ A	1 $\mu$ A	300 nA	100 nA	30 nA
	200 $\mu\Omega$	200 $\mu\Omega$	370 $\mu\Omega$	430 $\mu\Omega$	1.1 m $\Omega$	2.8 m $\Omega$	9.7 m $\Omega$	25 m $\Omega$	120 m $\Omega$
2 k $\Omega$	30 $\mu$ A	10 $\mu$ A	3 $\mu$ A	1 $\mu$ A	300 nA	100 nA	30 nA	10 nA	3 nA
	2.0 m $\Omega$	2.0 m $\Omega$	2.9 m $\Omega$	4.0 m $\Omega$	12 m $\Omega$	40 m $\Omega$	120 m $\Omega$	300 m $\Omega$	900 m $\Omega$
20 k $\Omega$	3 $\mu$ A	1 $\mu$ A	300 nA	100 nA	30 nA	10 nA	3 nA	1 nA	300 pA
	20 m $\Omega$	25 m $\Omega$	31 m $\Omega$	56 m $\Omega$	200 m $\Omega$	640 m $\Omega$	2.4 $\Omega$	5.3 $\Omega$	23 $\Omega$
200 k $\Omega$	300 nA	100 nA	30 nA	10 nA	3 nA	1 nA	300 pA	100 pA	30 pA
	250 m $\Omega$	350 m $\Omega$	640 m $\Omega$	1.4 $\Omega$	4.5 $\Omega$	16 $\Omega$	47 $\Omega$	150 $\Omega$	710 $\Omega$
2 M $\Omega$	30 nA	10 nA	3 nA	1 nA	300 pA	100 pA	30 pA	10 pA	3 pA
	3.4 $\Omega$	5.9 $\Omega$	16 $\Omega$	46 $\Omega$	190 $\Omega$	480 $\Omega$	1.7 k $\Omega$	5.4 k $\Omega$	15 k $\Omega$
20 M $\Omega$	3 nA	1 nA	300 pA	100 pA	30 pA	10 pA	3 pA	1 pA	300 fA
	50 $\Omega$	190 $\Omega$	540 $\Omega$	1.1 k $\Omega$	5.4 k $\Omega$	12 k $\Omega$	56 k $\Omega$	180 k $\Omega$	750 k $\Omega$

## General Characteristics

Interface	Serial (RS-232) through SIM interface
Connectors	DB-9 (female)
	AC 4-wire measurement + ground
	DB-15 (male) SIM interface
Weight	1.4 lbs
Dimensions	1.5" W $\times$ 3.6" H $\times$ 7.0" D



---

# 1 Getting Started

---

This chapter gives the user the necessary information to get started quickly with the SIM921 AC Resistance Bridge.

## In This Chapter

<b>1.1</b>	<b>Introduction to the Instrument</b> . . . . .	<b>1-2</b>
1.1.1	Overview . . . . .	1-2
<b>1.2</b>	<b>Front-Panel Operation</b> . . . . .	<b>1-3</b>
1.2.1	Resetting to factory defaults . . . . .	1-3
1.2.2	Numeric display . . . . .	1-3
1.2.3	Display . . . . .	1-3
1.2.4	Range . . . . .	1-5
1.2.5	Excite . . . . .	1-6
1.2.6	Output . . . . .	1-7
1.2.7	Autocal . . . . .	1-7
<b>1.3</b>	<b>Sensor Interface</b> . . . . .	<b>1-8</b>
1.3.1	Four-wire measurement . . . . .	1-9
1.3.2	Two-wire measurement . . . . .	1-9
1.3.3	Wiring for high impedance . . . . .	1-9
<b>1.4</b>	<b>SIM Interface</b> . . . . .	<b>1-11</b>
1.4.1	SIM interface connector . . . . .	1-11
1.4.2	Direct interfacing . . . . .	1-11

## 1.1 Introduction to the Instrument

The SIM921 AC Resistance Bridge monitors a single resistive sample—typically a cryogenic thermometer—with an adjustable AC current. With achievable excitation power below 100 aW, self-heating errors can be routinely eliminated.

### 1.1.1 Overview

The SIM921 uses a half-bridge topology, where the excitation current is passed through both an internal, stable reference resistor,  $R_R$ , and the user's resistive thermometer,  $R_M$  (see Figure 1.1). Eight separate reference resistors, from 1  $\Omega$  to 10 M $\Omega$ , are built into the instrument, with two expanded scales (200 m $\Omega$  and 20 m $\Omega$ ) implemented with additional gain.

The basic measurement is made by a pair of dual-phase demodulators to recover the vector AC voltage (amplitude and phase) developed across the internal reference resistor,  $V_R$  and across the user's resistor under measurement,  $V_M$ . The SIM921 determines the user's resistance value ratiometrically from

$$R_M = \frac{|\mathbf{V}_M|^2}{\mathbf{V}_R \bullet \mathbf{V}_M} \times R_R$$

By taking the in-phase component of  $\mathbf{V}_R$  in the ratio, the measurement is largely insensitive to capacitive loads in parallel with the  $R_M$ ; the phase shift they introduce is corrected in the denominator.

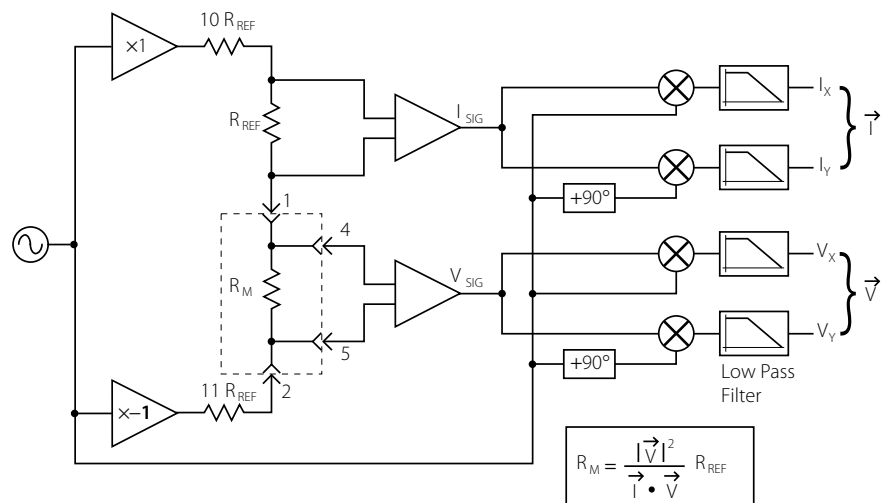

Figure 1.1: Block diagram of the SIM921.

## 1.2 Front-Panel Operation

The front panel of the SIM921 is divided into several major functional blocks, each of which will be discussed.



Figure 1.2: The SIM921 front panel.

### 1.2.1 Resetting to factory defaults

To reset the SIM921 to factory defaults, hold [Set ▲] depressed while turning power on to the module. This is equivalent to the remote command \*RST.

### 1.2.2 Numeric display

The upper block of the front panel is the numeric display field. In addition to 5 1/2 digits, six units LEDs ( $m\Omega$ ,  $\Omega$ ,  $k\Omega$ ,  $M\Omega$ ,  $mK$ , and  $K$ ) indicate the physical units of the quantity displayed. The two buttons to the left of the numeric display, [Set ▲▼], allow the user to modify settable parameters.

### 1.2.3 Display

Directly beneath [Set ▲▼] is the DISPLAY block of the panel. The two buttons at the bottom of this section, [Display ▲▼], select the quantity for display in the numeric field.

The selections are:

**Value :** The measured value of the user’s resistor-under-test is displayed, either in resistance units or temperature units (depending on the units selection, below).

When *Value* is displayed, pressing [Set ▼] acts as a short-cut to reset the output filter. This can be useful to speed settling with a long time constant after a large resistance change is made, or after the range or excitation is changed.

**Value–Offset :** This selection (also known as “deviation”) also displays the measurement result (either in resistance or temperature units), but after subtracting the user-settable Offset. Pressing [Set ▼] will reset the output filter.

**Phase (deg.) :** This selection shows the phase angle between measured current and voltage (in degrees), and is an indication of how much capacitive loading is present. Phase is positive for capacitive loads. A phase angle near +90° should be viewed with caution: this indicates that most of the current is flowing through the reactive part of the load, and measurement accuracy may suffer.

When phase is displayed, [Set ▲▼] can be used to modify the model used in the SIM921 to determine resistance. By pressing [Set ▼], the numeric display will show the word:  $\epsilon r o$ . This forces the meter to *assume* the phase angle between the voltage and current is zero when solving for  $R$ . This is helpful when measuring very small resistances (such as superconducting samples), since the phase determination becomes otherwise ill-conditioned when the voltage signal approaches zero, and causes excess noise in the results. Pressing [Set ▲] restores normal operation.

**Offset :** The offset, or setpoint, is the user-selected value to subtract from the sensor measurement. The offset is used in the *Value–Offset* display (above), as well as to determine the analog output voltage (see below). The [Set ▲▼] buttons will accelerate through multiple digits to adjust the offset; two short cuts also exist. If both [Set ▲] and [Set ▼] are pressed simultaneously, *Offset* is preloaded with the latest measurement result of *Value*. Depressing both buttons again will force *Offset* to zero.

**Freq. (Hz) :** This field controls the excitation frequency for the SIM921. [Set ▲▼] adjusts the frequency from 2 Hz to 60 Hz. Depressing both [Set ▲] and [Set ▼] together will step between 15 Hz, 10 Hz, 5 Hz, and 2.5 Hz.

$A_{OUT}$ : This parameter is the slope (in V/ $\Omega$  or V/K) used to scale the deviation signal for analog output. Use [Set ▲▼] to accelerate through many orders of magnitude for  $A_{OUT}$ ; releasing the button and re-pressing it allows fine control over the lower digits, as the setting begins accelerating again. If resistance units are selected for analog output, the  $\Omega$  indicator will be lit next to the numeric display; if temperature units are selected, the K indicator will be lit.

*Units* ( $\Omega$ , K): This is actually three separate selections that are stepped through by continuing to press [Display ▲▼]. The first selection lights both the *Value* and *Units* indicators. This selects either resistance or temperature units for the *Value* display. Use [Set ▲▼] to switch between resistance (the display will show  $r \text{ } \Omega$ ) and temperature (the display will show the ID message of the selected sensor calibration curve).

Pressing [Display ▼] again will light  $A_{OUT}$  and *Units* together. Now, [Set ▲▼] selects between resistance or temperature units for the analog output function. Note that the deviation display and offset parameter units are also determined by  $A_{OUT}$ -*Units*.

Pressing [Display ▼] one final time will leave *Units* lit alone. Now the [Set ▲▼] selects among three sensor calibration curves stored in the SIM921. If a particular curve has not been loaded, the  $\bar{\phantom{c}}$  is lit to indicate this is not a usable curve; once (at least) two points are loaded in a sensor curve memory, the display will show  $\star$  to the left of the curve ID. Only one curve can be selected at a time.

#### 1.2.4 Range

The RANGE block of the front panel selects the reference resistor. Press [Range ▲▼] to step between ranges from 20 m $\Omega$  to 20 M $\Omega$ . For all ranges  $\geq 2 \Omega$ , the reference resistor  $R_R$  is 1/2 the total range. For example, on the 20 k $\Omega$  range,  $R_R = 10 \text{ k}\Omega$ . For ranges  $\leq 2 \Omega$ , the  $R_R = 1.0 \Omega$ .

The Autorange subblock controls two independent functions related to range. Briefly tapping [Autorange] will toggle autorange *Display* on and off. When Autorange *Display* is off, the numeric display decimal point is fixed based on the selected range. With Autorange *Display* on, the decimal point (and possibly the units indicator) shifts to display the result with maximum resolution.

Holding [Autorange] for ~2 seconds light *Gain* and initiate an auto-gain cycle. Whenever the SIM921 is set to a new range or excitation, the internal amplifiers are preset to nominal gains. This might not be

optimal for measuring resistors that are much smaller than, or larger than, the nominal range setting. Also, if the user is in a high-noise environment, out-of-band pick-up might cause amplifier saturation. In either of these cases, initiating an autogain cycle will force the SIM921 to optimize gains *for the signals present at that time*. Once completed, the *Gain* is unlit, and the amplifier gains remain fixed at their new levels. Changing excitation or range will reset the amplifiers to their (new) nominal settings.

### 1.2.5 Excite

The EXCITE block controls the excitation amplitude for the measurement. [Excite ▲▼] step between excitation levels in 1–3–10 steps from 3  $\mu\text{V}$  to 30 mV. It is possible to step the amplitude setting down once more from the 3  $\mu\text{V}$  setting, setting the excitation amplitude to zero. Note that this does not close the shunting relay, as On/Off does (below).

The amplitude, together with the excitation mode, determines the actual conditions for the measurement. [Mode], at the bottom of the EXCITE block, is another dual-function control. Briefly tapping [Mode] toggles the excitation On/Off; when Off, a mechanical relay shunts the excitation current, preventing any current from flowing to the user's resistor.

While the excitation is off, holding [Mode] for  $\sim 2$  seconds will step between four (4) distinct excitation modes:

- Constant Current : With *Current* lit, the SIM921 will operate in constant current mode. This programs an AC current with rms amplitude of  $\text{excite}/R_R$ ; for example, if the excitation is set to 100  $\mu\text{V}$  and the range is 20 k $\Omega$ , the excitation current will equal 10 nA (100  $\mu\text{V}$  / 10 k $\Omega$  = 10 nA). This is implemented by servoing the measured voltage *across the reference resistor,  $R_R$*  to the selected excitation amplitude.
- Constant Voltage : With *Voltage* lit, the SIM921 will operate in constant voltage mode. In this mode, the excitation is servoed to keep the measured voltage *across the user's resistor,  $R_M$*  equal to the selected excitation. This can be particularly useful for negative tempco thermometers at low temperatures, where a constant current would lead to increasing power dissipation at lower temperatures ( $P = I^2 R_M$ ,  $R_M \uparrow$ ,  $P \uparrow$  as  $T \downarrow$ ). With constant voltage, the ohmic dissipation goes down with decreasing temperature ( $P = V^2/R_M$ ,  $R_M \uparrow$ ,  $P \downarrow$  as  $T \downarrow$ ).
- Constant Power : With both *Current* and *Voltage* lit, the SIM921 servoes the excitation to keep the power dissipated in the user's resistor



constant, at the level  $V^2/(R_R/2)$ .

Passive : With neither indicator lit, the SIM921 disables excitation servoing, and simply sets a fixed AC amplitude across the entire bridge circuit. The amplitude is set so that for  $R_M$  up to about the  $2R_R$ , the current will approximately equal the corresponding constant-current setting (above). For user resistances much larger than the range setting ( $R_M \gg R_R$ ), the voltage across the user resistor will approach  $\sim 20\times$  the nominal excitation (see Figure 1.1).

### 1.2.6 Output

The OUTPUT block of the front panel selects the post-detection filter setting, and contains the BNC connector for the analog output. The filter is a simple 6 dB/octave low pass filter that calculates a running exponential average of the vector voltages (prior to the ratio calculation). Higher settings of the time constant will reduce measurement noise at the expense of slower settling times. The filter affects the display values as well as the analog output voltages.

[Time Const. ▲▼]step the filter time constant in 1–3–10 steps from 0.3 s to 300 s. Stepping the time constant downwards from 0.3 s turns off the 6 dB/octave filter completely, leaving only a running boxcar “sync” filter (that averages the signals over the one excitation period) active. The sync filter effectively eliminates the  $2 \times f$  signals from the demodulator output, but otherwise provides little noise reduction. This is an appropriate setting for relatively high signal-to-noise measurements where signal bandwidth is important.

It can take six or seven time constants for the output of the SIM921 to fully settle after a step change; for slow time constant settings, this can be a bothersome delay. The filter can be reset by pressing [Set ▼] when the display is *Value* or *Value–Offset*.

### 1.2.7 Autocal

The AUTOCAL block controls the internal autocalibration of the SIM921. Autocalibration cross-calibrates the relative gain of the two amplifier chains in the system. The process takes about three (3) minutes to complete, and can be started by holding [Autocal] for  $\sim 2$  seconds. A countdown is displayed to indicate approximate time remaining. The autocalibration can be aborted by pressing [Autocal] again before the cycle completes—this will abandon the calibration in progress, and revert to the previous calibration values.

### 1.3 Sensor Interface

The sensor interface on the SIM921 consists a rear-panel DB-9/F connector, labeled “INPUT” (see Figure 1.3). The pin assignments for this connector are given in Table 1.1.

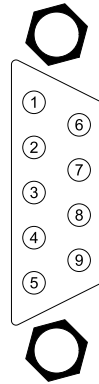

Pin	Signal
1	I+ (current lead)
2	I- (current lead)
3	ground
4	V+ (voltage lead)
5	V- (voltage lead)
6	ground
7	ground
8	ground
9	ground

Table 1.1: SIM921 Sensor Interface Connector Pins, DB-9. Drawing shows pin numbers looking into the rear of the instrument.

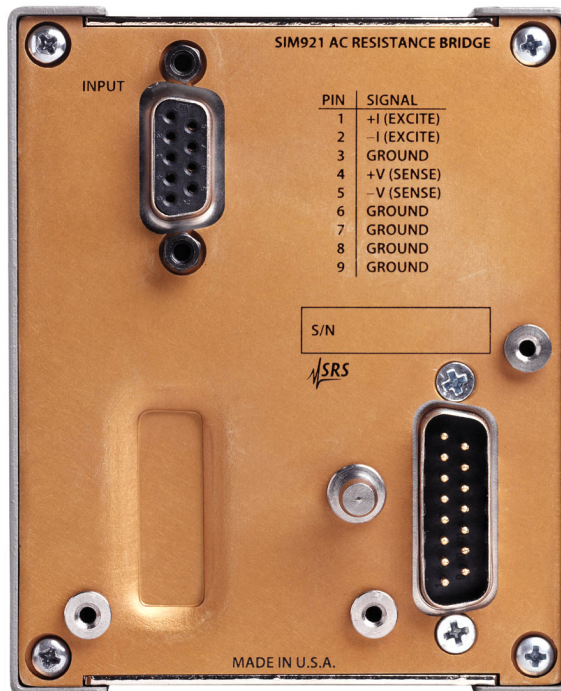

Figure 1.3: The SIM921 rear panel.

### 1.3.1 Four-wire measurement

To avoid sensitivity to wiring lead resistance, the SIM921 is configured for four-wire measurements. The basic circuit for this wiring scheme is shown in Figure 1.4.

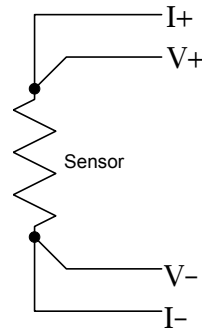

Figure 1.4: Wiring diagram for four-wire readout.

### 1.3.2 Two-wire measurement

If application-specific constraints limit the number of leads to the sensor, the SIM921 can be wired to measure the sensor resistance with a simple two-wire circuit, shown in Figure 1.5. Note that the lead resistance (past the junction points of the current and voltage leads) will add as a direct resistance error when measuring the sensor.

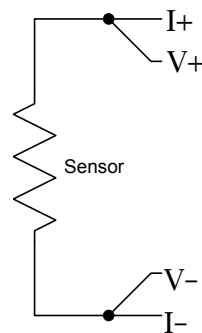

Figure 1.5: Wiring diagram for two-wire readout.

### 1.3.3 Wiring for high impedance

When using the SIM921 to measure high impedances ( $>$  few  $M\Omega$ ), cable construction becomes crucial. It is important that the wire leads have a low-loss dielectric insulation, such as PTFE (Teflon<sup>TM</sup>). Ordinary PVC-insulated wire is *not* well suited to this application, as it can suffer from dielectric absorption effects. Regardless of a

very high DC insulation resistance ( $> 100\text{ G}\Omega$ ), small AC dielectric losses, even at the low frequencies used by the SIM921, can appear as (10s~100s)  $\text{M}\Omega$  of *real* impedance in parallel with the user load.

## 1.4 SIM Interface

The primary connection to the SIM921 AC Resistance Bridge is the rear-panel DB-15 SIM interface connector. Typically, the SIM921 is mated to a SIM900 Mainframe via this connection, either through one of the internal mainframe slots, or the remote cable interface.

It is also possible to operate the SIM921 directly, without using the SIM900 Mainframe. This section provides details on the interface.



### CAUTION

*The SIM921 has no internal protection against reverse polarity, missing supply, or overvoltage on the power supply pins. Misapplication of power may cause circuit damage. SRS recommends using the SIM921 together with the SIM900 Mainframe for most applications.*

#### 1.4.1 SIM interface connector

The DB-15 SIM interface connector carries all the power and communications lines to the instrument. The connector signals are specified in Table 1.2

Pin	Signal	Direction Src ⇒ Dest	Description
1	SIGNAL_GND	MF ⇒ SIM	Ground reference for signal
2	-STATUS	SIM ⇒ MF	Status/service request (GND = asserted, +5 V = idle)
3	RTS	MF ⇒ SIM	HW handshake (+5 V = talk; GND = stop)
4	CTS	SIM ⇒ MF	HW handshake (+5 V = talk; GND = stop)
5	-REF_10MHZ	MF ⇒ SIM	10 MHz reference (optional connection)
6	-5 V	MF ⇒ SIM	Power supply (no connection in SIM921)
7	-15 V	MF ⇒ SIM	Power supply (analog circuitry)
8	PS_RTN	MF ⇒ SIM	Power supply return
9	CHASSIS_GND		Chassis ground
10	TXD	MF ⇒ SIM	Async data (start bit = "0" = +5 V; "1" = GND)
11	RXD	SIM ⇒ MF	Async data (start bit = "0" = +5 V; "1" = GND)
12	+REF_10MHz	MF ⇒ SIM	10 MHz reference (optional connection)
13	+5 V	MF ⇒ SIM	Power supply (digital circuitry)
14	+15 V	MF ⇒ SIM	Power supply (analog circuitry)
15	+24 V	MF ⇒ SIM	Power supply (no connection in SIM921)

Table 1.2: SIM Interface Connector Pin Assignments, DB-15

#### 1.4.2 Direct interfacing

The SIM921 is intended for operation in the SIM900 Mainframe, but users may wish to directly interface the module to their own systems without the use of additional hardware.

The mating connector needed is a standard DB-15 receptacle, such as Amp part # 747909-2 (or equivalent). Clean, well-regulated supply voltages of +5,  $\pm 15$  VDC must be provided, following the pin-out specified in Table 1.2. Ground must be provided on pins 1 and 8, with chassis ground on pin 9. The -STATUS signal may be monitored on pin 2 for a low-going TTL-compatible output indicating a status message.

#### 1.4.2.1 Direct interface cabling

If the user intends to directly wire the SIM921 independent of the SIM900 Mainframe, communication is usually possible by directly connecting the appropriate interface lines from the SIM921 DB-15 plug to the RS-232 serial port of a personal computer.<sup>1</sup> Connect RXD from the SIM921 directly to RD on the PC, TXD directly to TD, and similarly RTS→RTS and CTS→CTS. In other words, a null-modem style cable is *not* needed.

To interface directly to the DB-9 male (DTE) RS-232 port typically found on contemporary personal computers, a cable must be made with a female DB-15 socket to mate with the SIM921, and a female DB-9 socket to mate with the PC's serial port. Separate leads from the DB-15 need to go to the power supply, making what is sometimes know as a "hydra" cable. The pin-connections are given in Table 1.3.

DB-15/F to SIM921	Name
	DB-9/F
10 ↔ 3	TxD
11 ↔ 2	RxD
5	Computer Ground
	to P/S
7 ↔	-15 VDC
14 ↔	+15 VDC
13 ↔	+5 VDC
8,9 ↔	Ground (P/S return current)
1 ↔	Signal Ground (separate wire to Ground)

Table 1.3: SIM921 Direct Interface Cable Pin Assignments

<sup>1</sup> Although the serial interface lines on the DB-15 do not satisfy the minimum voltage levels of the RS-232 standard, they are typically compatible with desktop personal computers

#### 1.4.2.2 Serial settings

The serial port settings at power-on are: 9600 baud, 8–bits, no parity, 1 stop bit, and no flow control (see Section 2.3.1). The serial settings cannot be changed on the SIM921.





---

## 2 Remote Operation

---

This chapter describes operating the SIM921 over the serial interface.

### In This Chapter

<b>2.1</b>	<b>Index of Commands</b> . . . . .	<b>2-2</b>
<b>2.2</b>	<b>Alphabetic List of Commands</b> . . . . .	<b>2-4</b>
<b>2.3</b>	<b>Introduction</b> . . . . .	<b>2-7</b>
2.3.1	Power-on configuration . . . . .	2-7
2.3.2	Buffers . . . . .	2-7
2.3.3	Device Clear . . . . .	2-7
<b>2.4</b>	<b>Commands</b> . . . . .	<b>2-8</b>
2.4.1	Command syntax . . . . .	2-8
2.4.2	Notation . . . . .	2-9
2.4.3	Examples . . . . .	2-9
2.4.4	Excitation commands . . . . .	2-10
2.4.5	Measurement commands . . . . .	2-12
2.4.6	Post-detection processing commands . . . . .	2-14
2.4.7	Calibration curve commands . . . . .	2-15
2.4.8	Autoranging commands . . . . .	2-17
2.4.9	Autocalibration command . . . . .	2-17
2.4.10	Setpoint and analog output commands . . . . .	2-17
2.4.11	Interface commands . . . . .	2-18
2.4.12	Status commands . . . . .	2-23
<b>2.5</b>	<b>Status Model</b> . . . . .	<b>2-26</b>
2.5.1	Status Byte (SB) . . . . .	2-27
2.5.2	Service Request Enable (SRE) . . . . .	2-28
2.5.3	Standard Event Status (ESR) . . . . .	2-28
2.5.4	Standard Event Status Enable (ESE) . . . . .	2-29
2.5.5	Communication Error Status (CESR) . . . . .	2-29
2.5.6	Communication Error Status Enable (CESE) . . . . .	2-30
2.5.7	Overload Status (OVCR) . . . . .	2-30
2.5.8	Overload Status (OVSR) . . . . .	2-31
2.5.9	Overload Status Enable (OVSE) . . . . .	2-31

## 2.1 Index of Commands

symbol	definition
<i>i,j</i>	Integers
<i>f,g</i>	Floating-point values
<i>z</i>	Literal token
<i>s</i>	Arbitrary character sequence (no “,” or “;”)
(?)	Required for queries; illegal for set commands
<i>var</i>	Parameter always required
{ <i>var</i> }	Required parameter for set commands; illegal for queries
[ <i>var</i> ]	Optional parameter for both set and query forms

---

### Excitation

FREQ(?) { <i>f</i> }	2 – 10	Frequency
RANG(?) { <i>i</i> }	2 – 10	Range
EXCI(?) { <i>i</i> }	2 – 11	Excitation
EXON(?) { <i>z</i> }	2 – 11	Excitation On/Off
MODE(?) { <i>z</i> }	2 – 11	Excitation Mode
IEXC?	2 – 11	Query Excitation Current
VEXC?	2 – 11	Query Excitation Voltage

---

### Measurement

RVAL? [ <i>i</i> ]	2 – 12	Resistance Value
RDEV? [ <i>i</i> ]	2 – 12	Resistance Deviation
TVAL? [ <i>i</i> ]	2 – 12	Temperature Value
TDEV? [ <i>i</i> ]	2 – 13	Temperature Deviation
PHAS? [ <i>i</i> ]	2 – 13	Phase
TPER(?) { <i>i</i> }	2 – 13	Time Period for Streaming
SOUT	2 – 13	Stop Streaming
DISP(?) { <i>i</i> }	2 – 14	Display

---

### Post-Detection

FRST	2 – 14	Filter Reset
TCON(?) { <i>i</i> }	2 – 14	Time Constant
PHLD(?) { <i>z</i> }	2 – 15	Phase Hold

---

### CalCurves

DTEM(?) { <i>z</i> }	2 – 15	Display Temperature
ATEM(?) { <i>z</i> }	2 – 15	Analog Output Temperature
CURV(?) { <i>i</i> }	2 – 15	Sensor Calibration Curve
CINI(?) <i>i</i> { <i>z,s</i> }	2 – 16	Initialize Sensor Calibration
CAPT <i>i,f,g</i>	2 – 16	Add Point to Sensor Calibration
CAPT? <i>i,j</i>	2 – 16	Query Point in Sensor Calibration

---

**Autorange**

AGAI(?) {z}	2-17	Autorange Gain
ADIS(?) {z}	2-17	Autorange Display

---

**Autocalibration**

ACAL	2-17	Autocalibration
------	------	-----------------

---

**Setpoint/Analog Output**

RSET(?) {f}	2-17	Resistance Setpoint
TSET(?) {f}	2-18	Temperature Setpoint
VOHM(?) {f}	2-18	Analog Output Scale (V/ $\Omega$ )
VKEL(?) {f}	2-18	Analog Output Scale (V/K)
AMAN(?) {z}	2-18	Analog Output Manual Mode
AOUT(?) {f}	2-18	Analog Output Manual Value

---

**Interface**

*RST	2-19	Reset
*IDN?	2-20	Identify
*TST?	2-20	Self Test
*OPC(?)	2-20	Operation Complete
CONS(?) {z}	2-20	Console Mode
LEXE?	2-21	Execution Error
LCME?	2-21	Command Error
LBTN?	2-22	Button
TOKN(?) {z}	2-22	Token Mode
TERM(?) {z}	2-22	Response Termination

---

**Status**

*STB? [i]	2-23	Status Byte
*SRE(?) [i,] {j}	2-23	Service Request Enable
*CLS	2-23	Clear Status
PSTA(?) {z}	2-23	Pulsed Status Mode
*ESR? [i]	2-24	Standard Event Status
*ESE(?) [i,] {j}	2-24	Standard Event Status Enable
CESR? [i]	2-24	Communication Error Status
CESE(?) [i,] {j}	2-24	Communication Error Status Enable
OVCR? [i]	2-24	Overload Condition
OVSR? [i]	2-24	Overload Status
OVSE(?) [i,] {j}	2-25	Overload Status Enable

## 2.2 Alphabetic List of Commands

---

### ★

*CLS	2 – 23	Clear Status
*ESE(?) [i,] {j}	2 – 24	Standard Event Status Enable
*ESR? [i]	2 – 24	Standard Event Status
*IDN?	2 – 20	Identify
*OPC(?)	2 – 20	Operation Complete
*RST	2 – 19	Reset
*SRE(?) [i,] {j}	2 – 23	Service Request Enable
*STB? [i]	2 – 23	Status Byte
*TST?	2 – 20	Self Test

---

### A

ACAL	2 – 17	Autocalibration
ADIS(?) {z}	2 – 17	Autorange Display
AGAI(?) {z}	2 – 17	Autorange Gain
AMAN(?) {z}	2 – 18	Analog Output Manual Mode
AOUT(?) {f}	2 – 18	Analog Output Manual Value
ATEM(?) {z}	2 – 15	Analog Output Temperature

---

### C

CAPT <i>i,f,g</i>	2 – 16	Add Point to Sensor Calibration
CAPT? <i>i,j</i>	2 – 16	Query Point in Sensor Calibration
CESE(?) [i,]{j}	2 – 24	Communication Error Status Enable
CESR? [i]	2 – 24	Communication Error Status
CINI(?) <i>i</i> {z,s}	2 – 16	Initialize Sensor Calibration
CONS(?) {z}	2 – 20	Console Mode
CURV(?) {i}	2 – 15	Sensor Calibration Curve

---

### D

DISP(?) {i}	2 – 14	Display
DTEM(?) {z}	2 – 15	Display Temperature

---

### E

EXCI(?) {i}	2 – 11	Excitation
EXON(?) {z}	2 – 11	Excitation On/Off

---

### F

FREQ(?) {f}	2 – 10	Frequency
FRST	2 – 14	Filter Reset

**I**

---

 IEXC? 2-11 Query Excitation Current
 

---

**L**
 LBTN? 2-22 Button  
 LCME? 2-21 Command Error  
 LEXE? 2-21 Execution Error
 

---

**M**
 MODE(?) {z} 2-11 Excitation Mode
 

---

**O**
 OVCR? [i] 2-24 Overload Condition  
 OVSE(?) [i,]{j} 2-25 Overload Status Enable  
 OVSR? [i] 2-24 Overload Status
 

---

**P**
 PHAS? [i] 2-13 Phase  
 PHLD(?) {z} 2-15 Phase Hold  
 PSTA(?) {z} 2-23 Pulsed Status Mode
 

---

**R**
 RANG(?) {i} 2-10 Range  
 RDEV? [i] 2-12 Resistance Deviation  
 RSET(?) {f} 2-17 Resistance Setpoint  
 RVAL? [i] 2-12 Resistance Value
 

---

**S**
 SOUT 2-13 Stop Streaming
 

---

**T**
 TCON(?) {i} 2-14 Time Constant  
 TDEV? [i] 2-13 Temperature Deviation  
 TERM(?) {z} 2-22 Response Termination  
 TOKN(?) {z} 2-22 Token Mode  
 TPER(?) {i} 2-13 Time Period for Streaming  
 TSET(?) {f} 2-18 Temperature Setpoint  
 TVAL? [i] 2-12 Temperature Value
 

---

**V**
 VEXC? 2-11 Query Excitation Voltage  
 VKEL(?) {f} 2-18 Analog Output Scale (V/K)
 

---

VOHM(?) {f}

2 – 18 Analog Output Scale (V/ $\Omega$ )

## 2.3 Introduction

Remote operation of the SIM921 is through a simple command language documented in this chapter. Both set and query forms of most commands are supported, allowing the user complete control of the amplifier from a remote computer, either through the SIM900 Mainframe or directly via RS-232 (see Section 1.4.2.1).

See Table 1.2 for specification of the DB-15 SIM interface connector.

### 2.3.1 Power-on configuration

The settings for the remote interface are 9600 baud with no parity and no flow control, and local echo disabled (CONS OFF).

Most of the SIM921 instrument settings are stored in non-volatile memory, and at power-on the instrument returns to the state it was last in when power was removed. Exceptions are noted in the command descriptions.

Reset values of parameters are shown in **boldface**.

### 2.3.2 Buffers

Incoming data from the host interface is stored in a 64-byte input buffer. Characters accumulate in the input buffer until a command terminator (either <CR> or <LF>) is received, at which point the message is parsed and executed. Query responses from the SIM921 are buffered in a 64-byte output queue.

If the input buffer overflows, then all data in *both* the input buffer and the output queue are discarded, and an error is recorded in the CESR and ESR status registers.

### 2.3.3 Device Clear

The SIM921 host interface can be asynchronously reset to its power-on configuration by sending an RS-232-style <break> signal. From the SIM900 Mainframe, this is accomplished with the SRST command; if directly interfacing via RS-232, then use a serial break signal. After receiving the Device Clear, the interface is reset to 9600 baud and CONS mode is turned OFF. Note that this *only* resets the communication interface; the basic function of the SIM921 is left unchanged; to reset the instrument, see \*RST.

The Device Clear signal will also terminate any streaming outputs from the SIM921 due to a TVAL? or RVAL? query of multiple conversions.

## 2.4 Commands

This section provides syntax and operational descriptions for remote commands.

### 2.4.1 Command syntax

The four letter mnemonic (shown in **CAPS**) in each command sequence specifies the command. The rest of the sequence consists of parameters.

Commands may take either *set* or *query* form, depending on whether the “?” character follows the mnemonic. *Set only* commands are listed without the “?”, *query only* commands show the “?” after the mnemonic, and *optionally query* commands are marked with a “(?)”.

Parameters shown in { } and [ ] are not always required. Parameters in { } are required to set a value, and are omitted for queries. Parameters in [ ] are optional in both set and query commands. Parameters listed without any surrounding characters are always required.

Do *not* send ( ) or { } or [ ] as part of the command.

Multiple parameters are separated by commas. Multiple commands may be sent on one command line by separating them with semicolons (;) so long as the input buffer does not overflow. Commands are terminated by either <CR> or <LF> characters. Null commands and whitespace are ignored. Execution of command(s) does not begin until the command terminator is received.

tokens Token parameters (generically shown as z in the command descriptions) can be specified either as a keyword or integer value. Command descriptions list the valid keyword options, with each keyword followed by its corresponding integer value. For example, to set the response termination sequence to <CR>+<LF>, the following two commands are equivalent:

TERM CRLF      —or—      TERM 3

For queries that return token values, the return format (keyword or integer) is specified with the TOKN command.



### 2.4.2 Notation

The following table summarizes the notation used in the command descriptions:

Symbol	Definition
<i>i,j</i>	Integers
<i>f,g</i>	Floating-point values
<i>z</i>	Literal token
<i>s</i>	Arbitrary character sequence (no “,” or “;”)
(?)	Required for queries; illegal for set commands
<i>var</i>	Parameter always required
{ <i>var</i> }	Required parameter for set commands; illegal for queries
[ <i>var</i> ]	Optional parameter for both set and query forms

### 2.4.3 Examples

Each command is provided with a simple example illustrating its usage. In these examples, all data sent by the host computer to the SIM921 are set as *straight teletype font*, while responses received the host computer from the SIM921 are set as *slanted teletype font*.

The usage examples vary with respect to set/query, optional parameters, and token formats. These examples are not exhaustive, but are intended to provide a convenient starting point for user programming.

#### 2.4.4 Excitation commands

FREQ(?) {*f*}

Frequency

Set (query) the excitation frequency {to *f* Hz}.

The excitation frequency can be set with approximately 10 mHz resolution. The parameter *f* must be in the range  $1.95 \leq f \leq 61.1$ . The reset value is **10.0**.

*Example:* In the following, the excitation is set to 13.7 Hz.  
 FREQ 13.7; FREQ?  
 13.7025

RANG(?) {*i*}

Range

Set (query) the resistance range {to *i*}.

Valid range codes are:

<i>i</i>	Range
0	20 mΩ
1	200 mΩ
2	2 Ω
3	20 Ω
4	200 Ω
5	2 kΩ
6	20 kΩ
7	200 kΩ
8	2 MΩ
9	20 MΩ

*Example:* RANG 5

---

**EXCI(?) {i}**

Excitation

Set (query) the nominal excitation {to *i*}.

Valid excitation codes are:

<i>i</i>	Excitation
-1	0 (excitation off)
0	3 $\mu$ V
1	10 $\mu$ V
2	30 $\mu$ V
3	100 $\mu$ V
4	300 $\mu$ V
5	1 mV
6	3 mV
7	10 mV
8	30 mV

*Example:* EXCI?  
3

---

**EXON(?) {z}**

Excitation On/Off

Set (query) the excitation source {to *z*=(OFF 0, ON 1)}.

*Example:* EXON 1

---

**MODE(?) {z}**

Excitation Mode

Set (query) the excitation mode {to *z*=(**PASSIVE** 0, CURRENT 1, VOLTAGE 2, POWER 3)}.

*Example:* TOKN ON; MODE?  
PASSIVE

---

**IEXC?**

Query Excitation Current

Query the actual excitation current amplitude, in amperes.

*Example:* IEXC?  
+1.043700E-07

---

**VEXC?**

Query Excitation Voltage

Query the actual excitation voltage amplitude, in volts. This is the voltage measured across the sensor itself, not the “nominal” excitation across the entire bridge (set by EXCI).

*Example:* VEXC?  
+1.176760E-05

### 2.4.5 Measurement commands

---

RVAL? [ <i>i</i> ]	<p>Resistance Value</p> <p>Query the measured value of resistance, in ohms.</p> <p>If the optional <i>i</i> is specified, then <i>i</i> measurement results are returned to the host, separated by TPER milliseconds. If <i>i</i>=0 is specified, then streaming of RVAL? results continues indefinitely until the SOUT command is received.</p> <p><i>Example:</i> RVAL? 4  +1.130924E+02  +1.131047E+02  +1.130922E+02  +1.130764E+02</p>
<hr/>	
RDEV? [ <i>i</i> ]	<p>Resistance Deviation</p> <p>Query the measured value of resistance, in ohms, offset by the resistance setpoint (see RSET).</p> <p>If the optional <i>i</i> is specified, then <i>i</i> measurement results are returned to the host, separated by TPER milliseconds. If the optional <i>i</i> is specified, then <i>i</i> measurement results are returned to the host, separated by TPER milliseconds. If <i>i</i>=0 is specified, then streaming results continues indefinitely until the SOUT command is received.</p> <p><i>Example:</i> RSET 100  RDEV?  +1.308144E+01</p>
<hr/>	
TVAL? [ <i>i</i> ]	<p>Temperature Value</p> <p>Query the measured value of temperature, in kelvin.</p> <p>If the optional <i>i</i> is specified, then <i>i</i> measurement results are returned to the host, separated by TPER milliseconds. If the optional <i>i</i> is specified, then <i>i</i> measurement results are returned to the host, separated by TPER milliseconds. If <i>i</i>=0 is specified, then streaming results continues indefinitely until the SOUT command is received.</p> <p><i>Example:</i> TVAL?  +3.067459E+02</p>

---

---

TDEV? [ <i>i</i> ]	<p>Temperature Deviation</p> <p>Query the measured value of temperature, in kelvin, offset by the temperature setpoint (see TSET).</p> <p>If the optional <i>i</i> is specified, then <i>i</i> measurement results are returned to the host, separated by TPER milliseconds. If the optional <i>i</i> is specified, then <i>i</i> measurement results are returned to the host, separated by TPER milliseconds. If <i>i</i>=0 is specified, then streaming results continues indefinitely until the SOUT command is received.</p> <p><i>Example:</i> TSET 306 TDEV? +7.345581E-01</p>
<hr/>	
PHAS? [ <i>i</i> ]	<p>Phase</p> <p>Query the phase of the measured voltage (in degrees) with respect to the excitation current. Positive angles correspond to capacitive loads. This query disregards the PHLD setting.</p> <p>If the optional <i>i</i> is specified, then <i>i</i> measurement results are returned to the host, separated by TPER milliseconds. If the optional <i>i</i> is specified, then <i>i</i> measurement results are returned to the host, separated by TPER milliseconds. If <i>i</i>=0 is specified, then streaming results continues indefinitely until the SOUT command is received.</p> <p><i>Example:</i> PHAS? +0.022</p>
<hr/>	
TPER(?) { <i>i</i> }	<p>Time Period for Streaming</p> <p>Set (query) the time period {to <i>i</i>}, in ms. TPER can be set with 10 ms resolution in the range <math>100 \leq i \leq 6\,555\,350</math>. The reset value is <b>1000</b>.</p> <p><i>Example:</i> TPER 500</p>
<hr/>	
SOUT	<p>Stop Streaming</p> <p>Turn off streaming output.</p> <p>Streaming is also halted by the Device Clear signal (serial break), but <i>not</i> by *RST.</p> <p><i>Example:</i> TDEV?0 +8.273926E-01 +8.048706E-01 SOUT</p>

---

---

DISP(?) {*i*}                      Display  
 Set (query) the display selection {to *i*}.  
 Valid display codes are:

<i>i</i>	Display
0	Units
1	Units+A <sub>OUT</sub>
2	Units+Value
3	A <sub>OUT</sub>
4	Freq. (Hz)
5	Offset
6	Phase (deg.)
7	Value–Offset
8	Value

Example: DISP VALUE

#### 2.4.6 Post-detection processing commands

---

FRST                                  Filter Reset  
 Reset the post-detection filter.

Example: FRST

---

TCON(?) {*i*}                      Time Constant  
 Set (query) the time constant for the post-detection filter { to *i*}.  
 Valid time constant codes are:

<i>i</i>	Time Constant
-1	filter off (sync only)
0	0.3 s
1	1 s
2	3 s
3	10 s
4	30 s
5	100 s
6	300 s

Example: TCON 2

---

**PHLD(?) {z}**                      Phase Hold

Set (query) the phase hold mode {to z=(**OFF 0**, ON 1)}.

Forces the resistance calculation to assume zero phase. This mode is useful for measurements of very low resistance (such as superconducting transitions) where the raw signal-to-noise ratio becomes much less than unity.

*Example:* PHLD ON

### 2.4.7 Calibration curve commands

---

**DTEM(?) {z}**                      Display Temperature

Set (query) the display temperature mode {to z=(**OFF 0**, ON 1)}.

When ON, the SIM921 display for *Value* will be in temperature units instead of resistance.

*Example:* DTEM?  
ON

---

**ATEM(?) {z}**                      Analog Output Temperature

Set (query) the analog output temperature mode {to z=(**OFF 0**, ON 1)}.

When ON, the SIM921 generates an analog output proportional to temperature deviation instead of resistance deviation. Also, the display units for *Value–Offset* and *Offset* are set with ATEM.

*Example:* ATEM?  
1

---

**CURV(?) {i}**                      Sensor Calibration Curve

Set (query) the selected sensor calibration curve {to *i*}. Valid curve numbers are 1, 2, and 3. A curve number may be selected with CURV even if no corresponding curve has been loaded into the SIM921.

*Example:* CURV?  
2

---

 CINI(?)  $i \{z,s\}$ 

Initialize Sensor Calibration

Initialize sensor calibration curve  $i=(1, 2, \text{ or } 3)$ .

The set form of the command, CINI  $i,z,s$ , erases the old contents of curve  $i$ . The second parameter  $z=(\text{LINEAR } 0, \text{ SEMILOGT } 1, \text{ SEMILOGR } 2, \text{ LOGLOG } 3)$  defines the sensor curve format. The third parameter  $s$  is an arbitrary identification string for this sensor calibration curve. This string can consist of any non-blank characters *except* the comma “,” or semicolon “;”, and can be up to 15 characters in length. The leading 5 characters will be displayed on the SIM921 front panel when the curve is selected, within the limitations of the seven-segment display hardware.

*Example:* CINI 3, SEMILOGR, GRT\_75

The query form of the command, CINI?  $i$ , returns the following response:  $\langle \text{format} \rangle, \langle \text{serial} \rangle, n$

where  $\langle \text{format} \rangle$  is the calibration curve format (same as  $z$  above),  $\langle \text{serial} \rangle$  is the full identification string for the curve, and  $n$  is the number of points currently stored in the curve.

*Example:* CINI? 2  
LINEAR,PT100,225

---

 CAPT  $i,f,g$ 

Add Point to Sensor Calibration

Add a new point to sensor calibration curve  $i$ .  $f$  is the raw sensor value (in either ohms or  $\log_{10}(\text{ohms})$ , depending on curve format), and  $g$  is the corresponding temperature value (in either kelvin or  $\log_{10}(\text{kelvin})$ , again depending on curve format).

Note that curve points *must* be added in increasing order of sensor value  $f$ .

*Example:* CAPT 3, 3.223631, 127.542E-3 In the preceding, a point is added for  $R = 1.67352 \text{ k}\Omega$ ,  $T = 127.542 \text{ mK}$ . The curve format is SEMILOGR, so the raw sensor value transmitted is  $\log_{10}(1.67352 \times 10^3)$

---

 CAPT?  $i,j$ 

Query Point in Sensor Calibration

Query the value of sensor calibration curve  $i$ , entry point  $j$ .

The response is

 $\langle \text{sensor} \rangle, \langle \text{temperature} \rangle,$ 

where  $\langle \text{sensor} \rangle$  is the raw sensor value (in either ohms or  $\log_{10}(\text{ohms})$ , depending on curve format), and  $\langle \text{temperature} \rangle$  is the corresponding temperature value (in either kelvin or  $\log_{10}(\text{kelvin})$ , again depending on curve format).



Example: CAPT? 3,45  
3.223631E+00,1.275420E-01

### 2.4.8 Autoranging commands

---

**AGAI(?) {z}**                      Autorange Gain

Set (query) autoranging of gain {to z=(**OFF 0**, **ON 1**)}. When autoranging gain, the SIM921 will optimize signal-to-noise for the current and voltage measurement channels. After autoranging gain completes, the SIM921 automatically turns **AGAI OFF**. Nominal gains are restored by sending the **RANG** or **EXCI** commands, with either the prior setting or a new setting.

Note that if **AGAI** is *commanded* off with a remote command prior to the completion of the autoranging cycle, the internal gains will be left in an indeterminate state. To restore proper operation, either re-issue the **AGAI ON** command, or send a new **RANG** or **EXCI** command.

Example: AGAI ON

---

**ADIS(?) {z}**                      Autorange Display

Set (query) autoranging of the display {to z=(**OFF 0**, **ON 1**)}. The **ADIS** setting has no effect on the SIM921 measurement, and only modifies the front-panel data presentation.

Example: ADIS ON

### 2.4.9 Autocalibration command

---

**ACAL**                              Autocalibration

Initiate the internal autocalibration cycle (takes approximately 3 minutes). Remote commands will not be processed further until the autocalibration is completed.

Example: ACAL

### 2.4.10 Setpoint and analog output commands

---

**RSET(?) {f}**                      Resistance Setpoint

Set (query) the resistance setpoint {to *f* ohms}. This is the “offset” or “setpoint” value used in generating the analog output when **ATEM OFF**. The reset value is **1.0**.

Example: RSET?  
+1.000000E+02

---

TSET(?) {f}	<p>Temperature Setpoint</p> <p>Set (query) the temperature setpoint {to <i>f</i> kelvin}. This is the “offset” or “setpoint” value used in generating the analog output when ATEM ON. The reset value is <b>1.0</b>.</p> <p><i>Example:</i> TSET? +3.060000E+02</p>
<hr/>	
VOHM(?) {f}	<p>Analog Output Scale (V/Ω)</p> <p>Set (query) the analog output scale { to <i>f</i> V/Ω}. This is the scale used when ATEM OFF. The reset value is <b>1.0</b>.</p> <p><i>Example:</i> VOHM 1E-3</p>
<hr/>	
VKEL(?) {f}	<p>Analog Output Scale (V/K)</p> <p>Set (query) the analog output scale { to <i>f</i> V/K}. This is the scale used when ATEM ON. The reset value is <b>1.0</b>.</p> <p><i>Example:</i> VKEL? 1.000000E+00</p>
<hr/>	
AMAN(?) {z}	<p>Analog Output Manual Mode</p> <p>Set (query) the analog output manual mode {to <i>z</i>=(OFF 0, ON 1)}. When ON, the analog output is simply equal to the AOUT value; when OFF, the output is the scaled and offset measurement result.</p> <p><i>Example:</i> AMAN ON</p>
<hr/>	
AOUT(?) {f}	<p>Analog Output Manual Value</p> <p>Set (query) the Analog Output Manual value {to <i>f</i> volts}. This is the output value when AMAN ON. The initial value after power-on is <b>0.0</b>, but this value is <i>not</i> modified by *RST.</p> <p><i>Example:</i> AOUT -1.234</p>

#### 2.4.11 Interface commands

---

**\*RST**

## Reset

Reset the SIM921 to default configuration. \*RST executes the following commands:

- **FREQ 10**
- **RANG 6**
- **EXCI 1**
- **EXON ON**
- **MODE PASSIVE**
- **TPER 1000**
- **DISP 0**
- **TCON 1**
- **PHLD OFF**
- **DTEM OFF**
- **ATEM OFF**
- **ADIS ON**
- **RSET 1.0**
- **TSET 1.0**
- **VOHM 1.0**
- **VKEL 1.0**
- **AMAN OFF**
- **TOKN OFF**

Commands or settings which are *not* altered by \*RST are: SOUT, CURV, AOUT, CONS, TERM, PSTA, and all service-enable registers (\*SRE, \*ESE, CESE, OVSE).

*Example:* \*RST

---

*IDN?	<p>Identify</p> <p>Read the device identification string.</p> <p>The identification string is formatted as:  Stanford_Research_Systems,SIM921,s/n*****,ver#.#  where ***** is the 6-digit serial number, and #.# is the firmware revision level.</p> <p><i>Example:</i> *IDN?  Stanford_Research_Systems,SIM921,s/n003075,ver3.6</p>
<hr/>	
*TST?	<p>Self Test</p> <p>There is no self-test function. *TST will always return 0.</p> <p><i>Example:</i> *TST?  0</p>
<hr/>	
*OPC(?)	<p>Operation Complete</p> <p>Operation Complete. Sets the OPC flag in the ESR register.</p> <p>The query form *OPC? writes a 1 in the output queue when complete, but does not affect the ESR register.</p> <p><i>Example:</i> *OPC</p>
<hr/>	
CONS(?) {z}	<p>Console Mode</p> <p>Set (query) the console mode {to z=(OFF 0, ON 1)}.</p> <p>CONS causes each character received at the input buffer to be copied to the output queue.</p> <p>At power-on and Device-Clear, CONS is set to OFF.</p> <p><i>Example:</i> CONS?  0</p>

---

---

**LEXE?****Execution Error**

Query the last execution error code. A query of LEXE? always clears the error code, so a subsequent LEXE? will return 0. Valid codes are:

Value	Definition
0	No execution error since last LEXE?
1	Illegal value
2	Wrong token
3	Invalid bit
16	Uninitialized curve
17	Curve full
18	Curve point out-of-order
19	Curve point past end

*Example:* \*STB? 12; LEXE?; LEXE?

3

0 The error (3, "Invalid bit,") is because \*STB? only allows bit-specific queries of 0–7. The second read of LEXE? returns 0.

---

**LCME?****Command Error**

Query the last command error code. A query of LCME? always clears the error code, so a subsequent LCME? will return 0. Valid codes are:

Value	Definition
0	No execution error since last LCME?
1	Illegal command
2	Undefined command
3	Illegal query
4	Illegal set
5	Missing parameter(s)
6	Extra parameter(s)
7	Null parameter(s)
8	Parameter buffer overflow
9	Bad floating-point
10	Bad integer
11	Bad integer token
12	Bad token value
13	Bad hex block
14	Unknown token

*Example:* \*IDN

LCME?

4 The error (4, "Illegal set") is due to the missing "?".

## LBTN?

## Button

Query the last button-press code. A query of LBTN? always clears the button code, so a subsequent LBTN? will return 0. Valid codes are:

Value	Definition
0	no button pressed since last LBTN?
1	[Display ▼]
2	[Display ▲]
3	[Set ▼]
4	[Set ▲]
5	undef
6	[Excite ▼]
7	[Excite ▲]
8	[Range ▼]
9	[Range ▲]
10	[Autocal]
11	[Autorange]
12	[Mode]
13	[Time Const. ▼]
14	[Time Const. ▲]

*Example:* LBTN?  
12

## TOKEN(?) {z}

## Token Mode

Set (query) the Token Query mode {to z=(OFF 0, ON 1)}.

If TOKEN ON is set, then queries to the SIM921 that return tokens will return the text keyword; otherwise they return the decimal integer value.

An interesting illustration of this is the observation that the only possible responses to the TOKEN? query are ON and 0.

At power-on, TOKEN is set to OFF.

*Example:* TOKEN OFF

## TERM(?) {z}

## Response Termination

Set (query) the <term> sequence {to z=(NONE 0, CR 1, LF 2, CRLF 3, LFCR 4)}. The <term> sequence is appended to all query responses sent by the module, and is constructed of ASCII character(s) 13 (carriage return) and 10 (line feed). The token mnemonic gives the sequence of characters.

At power-on, TERM is set to CRLF.

*Example:* TERM?  
3

### 2.4.12 Status commands

The Status commands query and configure registers associated with status reporting of the SIM921.

---

*STB? [i]	Status Byte Reads the Status Byte register [bit i]. The *STB? query causes the –STATUS signal to be released if asserted. (See also PSTA)
<i>Example:</i>	*STB? 16
*SRE(?) [i,] {j}	Service Request Enable Set (query) the Service Request Enable register [bit i] {to j}.
firmware release 4.0	Note that bit 1 of the SRE implements a local (front-panel) keypad lockout function. Setting bit 1 (*SRE 1, 1) disables the keypad. Clearing bit 1 (*SRE 1, 0) re-enables the front panel.
<i>Example:</i>	*SRE 0, 1
*CLS	Clear Status *CLS immediately clears the ESR, CESR, and OVSR.
<i>Example:</i>	*CLS
PSTA(?) {z}	Pulsed Status Mode Set (query) the Pulse –STATUS Mode {to z=(OFF 0, ON 1)}.
	When PSTA ON is set, any new service request will only <i>pulse</i> the –STATUS signal low (for a minimum of 1 $\mu$ s). The default behavior is to latch –STATUS low until a *STB? query is received.
	On reset, PSTA is set to OFF.
<i>Example:</i>	PSTA? OFF

---

---

*ESR? [ <i>i</i> ]	<p>Standard Event Status</p> <p>Reads the Standard Event Status Register [bit <i>i</i>].</p> <p>Upon executing *ESR?, the returned bit(s) of the ESR register are cleared.</p> <p><i>Example:</i> *ESR? 64</p>
<hr/>	
*ESE(?) [ <i>i</i> ,] { <i>j</i> }	<p>Standard Event Status Enable</p> <p>Set (query) the Standard Event Status Enable Register [bit <i>i</i>] {to <i>j</i>}.</p> <p><i>Example:</i> *ESE 6, 1 ESE? 64</p>
<hr/>	
CESR? [ <i>i</i> ]	<p>Communication Error Status</p> <p>Query Communication Error Status Register [for bit <i>i</i>].</p> <p>Upon executing a CESR? query, the returned bit(s) of the CESR register are cleared.</p> <p><i>Example:</i> CESR? 0</p>
<hr/>	
CESE(?) [ <i>i</i> ,]{ <i>j</i> }	<p>Communication Error Status Enable</p> <p>Set (query) Communication Error Status Enable Register [for bit <i>i</i>] {to <i>j</i>}</p> <p><i>Example:</i> CESE? 0</p>
<hr/>	
OVCR? [ <i>i</i> ]	<p>Overload Condition</p> <p>Query Overload Condition Register [for bit <i>i</i>].</p> <p><i>Example:</i> OVCR? 0</p>
<hr/>	
OVSR? [ <i>i</i> ]	<p>Overload Status</p> <p>Query Overload Status Register [for bit <i>i</i>].</p> <p>Upon executing a OVSR? query, the returned bit(s) of the OVSR register are cleared.</p> <p><i>Example:</i> OVSR? 0</p>

---



---

OVSE(?) [*i*]{*j*}                      Overload Status Enable  
Set (query) Overload Status Enable Register [for bit *i*] {to *j*}

*Example:* OVSE 3

## 2.5 Status Model

The SIM921 status registers follow the hierarchical IEEE–488.2 format. A block diagram of the status register array is given in Figure 2.1.

There are three categories of registers in the SIM921 status model:

**Condition Registers :** These read-only registers correspond to the real-time condition of some underlying physical property being monitored. Queries return the latest value of the property, and have no other effect. Condition register names end with CR.

**Event Registers :** These read-only registers record the occurrence of defined events. When the event occurs, the corresponding bit is set to 1. Upon querying an event register, any set bits within it are cleared. These are sometimes known as “sticky bits,” since once set, a bit can only be cleared by reading its value. Event register names end with SR.

**Enable Registers :** These read/write registers define a bitwise mask for their corresponding event register. If any bit position is set in an event register while the same bit position is also set in the enable register, then the corresponding summary bit message is set. Enable register names end with SE.

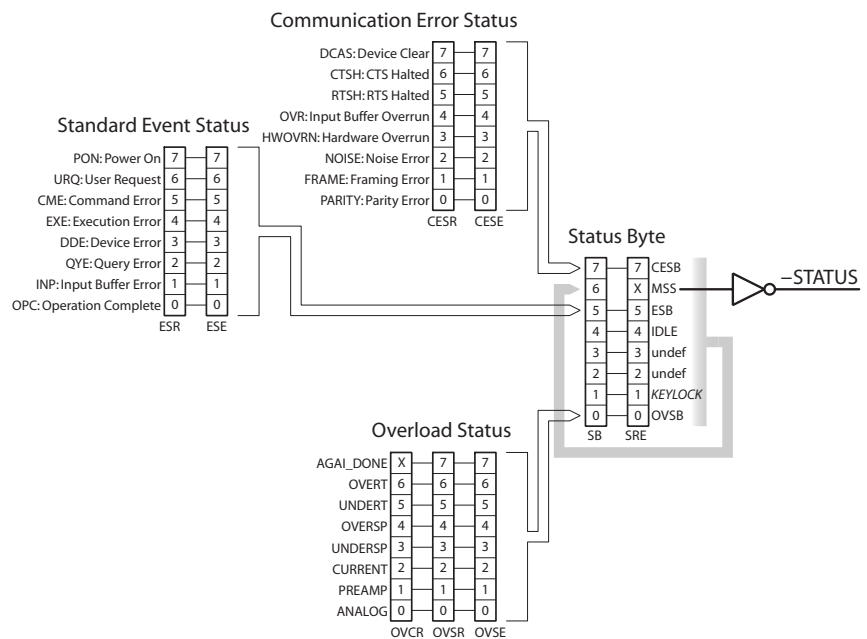

Figure 2.1: Status Register Model for the SIM921 AC Resistance Bridge.

### 2.5.1 Status Byte (SB)

The Status Byte is the top-level summary of the SIM921 status model. When masked by the Service Request Enable register, a bit set in the Status Byte causes the  $\text{-STATUS}$  signal to be asserted on the rear-panel SIM interface connector.

Typically,  $\text{-STATUS}$  remains asserted (low) until a  $\text{*STB?}$  query is received, at which time  $\text{-STATUS}$  is deasserted (raised)<sup>1</sup>. After clearing the  $\text{-STATUS}$  signal, it will only be re-asserted in response to a *new* status-generating condition.

Weight	Bit	Flag
1	0	OVSB
2	1	undef (0)
4	2	undef (0)
8	3	undef (0)
16	4	IDLE
32	5	ESB
64	6	MSS
128	7	CESB

**OVSB :** Overload Status Summary Bit. Indicates whether one or more of the enabled flags in the Overload Status Register has become true.

**IDLE :** Indicates that the input buffer is empty and the command parser is idle. Can be used to help synchronize SIM921 query responses.

**ESB :** Event Status Bit. Indicates whether one or more of the enabled events in the Standard Event Status Register is true.

**MSS :** Master Summary Status. Indicates whether one or more of the enabled status messages in the Status Byte register is true. Note that while  $\text{-STATUS}$  is released by the  $\text{*STB?}$  query, MSS is only cleared when the underlying enabled bit message(s) are cleared.

**CESB :** Communication Error Summary Bit. Indicates whether one or more of the enabled flags in the Communication Error Status Register has become true.

Bits in the Status Byte are *not* cleared by the  $\text{*STB?}$  query. These bits are only cleared by reading the underlying event registers, or by clearing the corresponding enable registers.

<sup>1</sup> but see the PSTA command

### 2.5.2 Service Request Enable (SRE)

Each bit in the SRE corresponds one-to-one with a bit in the SB register, and acts as a bitwise AND of the SB flags to generate the MSS bit in the SB and the  $\text{-STATUS}$  signal.

Weight	Bit	Flag
1	0	OVS Enable
2	1	KEYLOCK
4	2	undef (0)
8	3	undef (0)
16	4	IDLE Enable
32	5	ESB Enable
64	6	undef (0)
128	7	CESB Enable

Bit 6 of the SRE is undefined—setting it has no effect, and reading it always returns 0. This register is set and queried with the  $\text{*SRE(?)}$  command.

firmware release 4.0

Bit 1 of the SRE (binary weight 2) is a special function, “KEYLOCK”, and is unrelated to the SIM921 status system. Setting this bit results in the SIM921 ignoring all front panel key presses, essentially implementing a local lockout function.

This register is cleared at power-on.

### 2.5.3 Standard Event Status (ESR)

The Standard Event Status register consists of 8 event flags. These event flags are all “sticky bits” that are set by the corresponding event, and cleared only by reading or with the  $\text{*CLS}$  command. Reading a single bit (with the  $\text{*ESR? } i$  query) clears only bit  $i$ .

Weight	Bit	Flag
1	0	OPC
2	1	INP
4	2	QYE
8	3	DDE
16	4	EXE
32	5	CME
64	6	URQ
128	7	PON

OPC : Operation Complete. Set by the  $\text{*OPC}$  command.

INP : Input buffer Error. Indicates data has been discarded from the input buffer.

QYE : Query Error. Indicates data in the output queue has been lost.

DDE : Device Dependent Error. Undefined for SIM921.

EXE : Execution Error. Indicates an error in a command that was successfully parsed. Out-of-range parameters are an example. The error code can be queried with LEXE?.

CME : Command Error. Indicates a parser-detected error. The error code can be queried with LCME?.

URQ : User Request. Indicates a front-panel button was pressed.

PON : Power On. Indicates that an off-to-on transition has occurred.

#### 2.5.4 Standard Event Status Enable (ESE)

The ESE acts as a bitwise AND with the ESR register to produce the single bit ESB message in the Status Byte Register (SB). It can be set and queried with the \*ESE(?) command.

This register is cleared at power-on.

#### 2.5.5 Communication Error Status (CESR)

The Communication Error Status register consists of 8 event flags; each of which is set by the corresponding event, and cleared only by reading or with the \*CLS command. Reading a single bit (with the CESR? *i* query) clears only bit *i*.

Weight	Bit	Flag
1	0	PARITY
2	1	FRAME
4	2	NOISE
8	3	HWOVRN
16	4	OVR
32	5	RTSH
64	6	CTSH
128	7	DCAS

PARITY : Parity Error. Set by serial parity mismatch on incoming data byte.

FRAME : Framing Error. Set when an incoming serial data byte is missing the STOP bit.

NOISE : Noise Error. Set when an incoming serial data byte does not present a steady logic level during each asynchronous bit-period window.

HWOVRN : Hardware Overrun. Set when an incoming serial data byte is lost due to internal processor latency. Causes the input buffer to be flushed, and resets the command parser.

- OVR : Input buffer Overrun. Set when the input buffer is overrun by incoming data. Causes the input buffer to be flushed, and resets the command parser.
- RTSH : Undefined for the SIM921. Command Error. Indicates a parser-detected error.
- CTSH : Undefined for the SIM921.
- DCAS : Device Clear. Indicates the SIM921 received the Device Clear signal (an RS-232 <break>). Clears the input buffer and output queue, and resets the command parser.

### 2.5.6 Communication Error Status Enable (CESE)

The CESE acts as a bitwise AND with the CESR register to produce the single bit CESB message in the Status Byte Register (SB). It can be set and queried with the CESE(?) command.

This register is cleared at power-on.

### 2.5.7 Overload Status (OVCR)

The Overload Condition Register consists of 7 single-bit monitors of condition events within the SIM921. Bits in the OVCR reflect the real-time values of their corresponding signals. Reading the entire register, or individual bits within it, does not affect the OVCR.

Weight	Bit	Flag
1	0	ANALOG
2	1	PREAMP
4	2	CURRENT
8	3	UNDERSP
16	4	OVERSP
32	5	UNDERT
64	6	OVERT
128	7	undef (0)

ANALOG : Analog overload. A signal amplifier was saturated.

PREAMP : The front-end preamp saturated.

CURRENT : The excitation current exceeded 12 mA (saturation).

UNDERSP : The excitation servo fell below 90 % of the commanded excitation.

OVERSP : The excitation servo exceeded 110 % of the commanded excitation.

UNDERT : Calibration curve underflow ( $R < R_{\min}$ ).

OVERT : Calibration curve overflow ( $R > R_{\min}$ ).

### 2.5.8 Overload Status (OVSR)

The Overload Status Register consists of (latching) event flags that correspond one-to-one with the bits of the OVCR (see above). Upon the transition  $0 \rightarrow 1$  of any bit within the OVCR, the corresponding bit in the OVSR becomes set.

Bits in the OVSR are unaffected by the  $1 \rightarrow 0$  transitions in the OVCR, and are cleared only by reading or with the \*CLS command. Reading a single bit (with the OVSR? *i* query) clears only bit *i*.

An additional bit, AUTOGAIN\_DONE (weight=128, bit=7) is defined in the OVSR to signal completion of an autorange gain cycle.

### 2.5.9 Overload Status Enable (OVSE)

The OVSE acts as a bitwise AND with the OVSR register to produce the single bit OVSB message in the Status Byte Register (SB). It can be set and queried with the OVSE(?) command.

This register is cleared at power-on.





---

## 3 Parts Lists and Schematics

---

This chapter presents a brief description of the SIM921 circuit design. A complete parts list and circuit schematics are included.

### In This Chapter

<b>3.1</b>	<b>Circuit Discussion</b>	<b>3-2</b>
3.1.1	Digital board	3-2
3.1.2	Front-panel board	3-3
3.1.3	Source board	3-3
3.1.4	Amplifier Board	3-4
<b>3.2</b>	<b>Parts Lists</b>	<b>3-6</b>
3.2.1	Digital and Front Panel Boards	3-6
3.2.2	Source Board	3-7
3.2.3	Amplifier Board	3-8
<b>3.3</b>	<b>Schematic Diagrams</b>	<b>3-8</b>

## 3.1 Circuit Discussion

The SIM921 is assembled from 4 interconnected printed circuit boards: three full-sized boards running the length of the module, and one front-panel display board. In this chapter, page references are to the 9-sheet schematics pages at the end of the manual.

### 3.1.1 Digital board

The digital board (pages 1, 2, & 3) contains the microcontroller chip, digital I/O, and the analog-to-digital and digital-to-analog converters. Be aware that the four mounting screws securing this board to the chassis are “locked” by the threaded stand-offs holding the source board. Before attempting to remove these screws, the amplifier board, source board, and threaded stand-offs must be removed, or the screws will likely strip or break.

#### 3.1.1.1 Clock and MCU

All functions of the SIM921 are coordinated by the microcontroller, U103, which operates in “single-chip” mode (internal RAM and ROM). Extended non-volatile memory is provided by U105 for storage of user calibration curves. The clock circuit (Y101, U102, and related components) is a modified Pierce oscillator. In the presence of an external 10 MHz reference clock from the SIM900 Mainframe, the oscillator will lock to the reference (over a several hundred Hertz window) through the coupling of R108. If no external 10 MHz reference is present, then the oscillator simply free-runs.

#### 3.1.1.2 Sine generator

The excitation sine-wave is created with a ~4 kHz direct digital synthesis. DAC U208 is updated with new values every ~250  $\mu$ s; these values are calculated from a sine table with interpolation, scaled for excitation amplitude. For small amplitudes, U215 can switch in a divide-by-100 feedback network. The result is sent to the analog source board via JS202.

#### 3.1.1.3 *I* and *V* Analog-to-Digital converter

The main signals from the amplifier board, *I*.SIGNAL and *V*.SIGNAL, are received at JS202 (which interconnects with both analog boards). The signals are Nyquist filtered with 3-pole Butterworth low-pass filters (U201A & U202A), and then summed with a DAC-generated dither signal (U206) to increase the effective resolution and linearity

of the ADC. The main converter, U207, is a 14-bit simultaneously-sampling two-channel analog-to-digital converter, read out at a sample rate of ~4 kHz.

#### 3.1.1.4 Analog output

The front-panel analog output is generated at U210, a 12-bit digital-to-analog converter. This DAC is updated at ~4 kHz with the sum of the slowly-varying output signal and a high-frequency random dither. The 6-pole, 10 Hz output Bessel low-pass filter (U211 & U212) completely blocks the dither component, providing a 16-bit output resolution.

### 3.1.2 Front-panel board

The front-panel board (page 3) contains the drive circuitry for the display components of the SIM921. Note that all LEDs are driven *statically* from U307–U318.

The readout for the button switches is somewhat subtle. Initially, the BUTTON\_SENSE lines are all *driven* low, and the BUTTON\_PRESS lines are diode-or'd together (D103, D104, page 1) to detect any button closure. Once a button closure is detected, the the BUTTON\_SENSE lines are changed into *inputs*, and the BUTTON\_PRESS lines are driven high, one-by-one, to decode which button(s) are pressed.

### 3.1.3 Source board

The analog source board (pages 4, 5, & 6) receives the SINE\_GEN output from the sine-wave generator, filters it, and switches in the appropriate half-bridge set of resistors for the selected range.

#### 3.1.3.1 Excitation circuit

The attenuator selector (U403) is only switched between the top three settings (EXC\_FULL, EXC\_/3, EXC\_/10); greater attenuations are switched in with U215, or by reducing the numeric amplitude of the sine table values. After attenuating, the signal is filtered and split into complementary polarities,  $\pm$ EXCITE. The first two poles of the low-pass filter are implemented by U401A, while the last two poles are implemented separately for the two polarities by U402A & B. In the middle of this filter, the inverted polarity is generated by U401B, and the DC-offset of both polarities is blocked by C403 & C407. Notice that after the blocking capacitors, a low-offset (non-A) grade opamp must be used for U402.

### 3.1.3.2 Reference resistor bridges

Each range from  $1\ \Omega$  to  $100\ \text{M}\Omega$  has its own half-bridge network (page 5), all driven by  $\pm\text{EXCITE}$ . The selected range is switched to the  $\pm\text{I.EXCITE}$  leads to the user's (external) resistor through one of relays K509–K516, while the corresponding (internal) reference resistor R512–R519 is switched onto  $\pm\text{I.SENSE}$  with one of K501–K508. The trim-pots (R536–R543) are all accessible through the top ventilation slots, and factory-adjusted to balance the top and bottom legs of the half-bridges.

Relay K517 shorts the  $\pm\text{I.EXCITE}$  lines to each other and ground. This relay is closed whenever the excitation is commanded off, and also upon power-off by the one-shot circuit around U501.

Notice that  $\pm\text{I.EXCITE}$  is connected to the amplifier board by JP603 near the upper-rear corner of the board, while  $\pm\text{I.SENSE}$  is connected to the amplifier board by JP602 near the lower-front corner of the board. These signals are routed as far from each other as possible to minimize cross-talk.

### 3.1.3.3 Interconnect

The main connection for power, control, and high-level analog signals is JP601. Note that this is a “tall” header, with pins extending through both sides of the source board. This connector mates with JS202 on the digital board, and also with JS901 on the amplifier board.

## 3.1.4 Amplifier Board

All the circuitry on the preamp board (pages 7, 8, & 9) is duplicated identically, as much as possible, for the two signal paths,  $V$  and  $I$ .

### 3.1.4.1 Preamplifiers

The two signals  $\pm\text{V.SENSE}$  come from the Kelvin (voltage-sense) leads across the user's external resistor under measurement, while the  $\pm\text{I.SENSE}$  signals are the sense leads from the internal reference resistor (page 5). Under normal operation, relays K701 & K702 are in the reset position, connecting the  $\pm\text{V.SENSE}$  to the  $V$ -channel preamp (Q702 and associated circuitry), and connecting  $\pm\text{I.SENSE}$  to the  $I$ -channel preamp (Q701 and associated). The preamps are fixed gain ( $10\times$ ), high-impedance DC-coupled voltage amplifiers using the LSK389 dual JFET for inputs.

During an autocalibration cycle, the two relays K701, K702 are both switched to the set position, tying both preamps to the  $\pm\text{I.SENSE}$  internal signal (K517 is also switched closed, providing a complete

internal current path, and disconnecting all circuitry from the external resistor). Since the fundamental measurement of the SIM921 is ratiometric, this cross-calibration of the two amplifier channels is sufficient to remove gain-dependent systematic errors in the resistance measurement.

#### 3.1.4.2 Programmable gain amplifier

Page 8 shows the two (identical) channels of programmable gain amplifier. Each amplifier is constructed of two stages of variable gain (up to +50 dB), connected by a variable attenuator and AC-coupling stage. The  $-3$  dB point for the AC-coupling is  $\sim 1.6$  Hz. Note that the factory calibration includes a model for each of these AC-coupling filters, so to first order the autocalibration cycle should not be necessary when changing excitation frequencies.

#### 3.1.4.3 RF filtering

The 4 signals that connect to the external resistor under measurement ( $\pm I\_EXCITE$  and  $\pm V\_SENSE$ ) each pass through an L-R-C  $\pi$ -filter located right behind the external DB-9 connector (JS904).

## 3.2 Parts Lists

The parts lists are separated by the internal (SRS) assembly kit, which consist of one or two boards each.

### 3.2.1 Digital and Front Panel Boards

Reference	SRS P/N	Part Value	Reference	SRS P/N	Part Value
C101	5-00345	4.0-34P	R206,R201	4-01270	39.2K
C102	5-00366	18P	R207,R202	4-01296	73.2K
C103	5-00376	120P	R203,R205,R208,R209	4-01251	24.9K
C104	5-00368	27P	R210,R204	4-01020	97.6
C105,C106,C107	5-00102	4.7U	R211	4-01259	30.1K
C108,C109,C110	5-00387	1000P	R212,R216,R220	4-01213	10.0K
C206,C201	5-00455	.012U	R213	4-01217	11.0K
C202,C205	5-00450	.0047U	R214	4-01209	9.09K
C203,C207	5-00442	.001U	R215,R218,R219,R221	4-01242	20.0K
C204,C208	5-00367	22P	R217	4-01046	182
C212,C209	5-00369	33P	R222	4-01287	59.0K
C210,C219	5-00375	100P	R223	4-01362	357K
C211	5-00454	.01U	R224	4-01297	75.0K
C213,C215,C217	5-00466	.1U/MF	R225	4-01347	249K
C216,C214	5-00462	.047U	R226	4-01312	107K
C218	5-00456	.015U	R227	4-01370	432K
C220	5-00318	2.2U/T35	R228	4-01163	3.01K
C221	5-00471	10U/T16	R229	4-01165	3.16K
C222,C223,C224,C225,C226	5-00298	.01U	R230	4-01021	100
C227	5-00542	1.0U	R239	4-01146	2.00K
D101,D102	3-00945	BAT54S	R240,R241,R242	4-01280	49.9K
D103,D104	3-00649	BAW56LT1	R243,R244	4-01519	47K
D301,D302,D303,D304,D305, D306,D307,D308,D309,D310, D311,D312,D313,D314,D315, D316,D317,D318,D319,D320, D321,D322,D323,D324,D326, D327,D328,D329,D330,D331, D332,D333,D334,D335,D336, D337,D338,D339,D340,D341, D342,D343,D344	3-00424	GREEN	R301	4-01489	2.7K
D325	3-00426	YELLOW	S301,S302,S303,S304,S305, S306,S307,S308,S309,S310, S311,S312,S313	2-00053	B3F-1052
JP101	1-00302	6 PIN DIF CES	U101	3-00903	MAX6348
JP103	1-00367	15 PIN D	U102	3-01378	74HCU04
JP301	1-00219	TMS-115-01-G-S	U103	3-01379	68HC912B32
JS201	1-00003	BNC	U104	3-00662	74HC14
JS202	1-00104	HEADER 8X2	U105	3-01390	25LC640
JS301	1-00351	SMS-115-01-G-S	U106	3-00902	74HC00
L101,L102,L103	6-00174	BEAD	U202,U201	3-01385	OPA2137
Q201,Q202	3-00580	MMBT3906LT1	U203	3-00726	LF412
RN301,RN302,RN303,RN304, RN305,RN306,RN307,RN308, RN309,RN310,RN311	4-00407	2.7K	U204,U205,U213	3-01373	OPA2277UA
RN312,RN313,RN314,RN315, RN316,RN317,RN318,RN319, RN320,RN321,RN322,RN323	4-00442	1.2K	U206	3-01391	TLC7528
R101	4-01495	4.7K	U207	3-01392	AD7863AR-10
R102	4-01511	22K	U210,U208	3-01393	AD7545A
R103	4-01431	10	U209	3-00542	AD587JR
R104,R106,R113,R118,R245, R246	4-01503	10K	U211,U212	3-00724	LF353
R105,R107,R234,R235,R236, R237,R238	4-01479	1.0K	U214	3-00116	78L05
R108	4-01057	237	U215	3-01371	DG417DY
R109	4-01405	1.00M	U216	3-00952	OPA2277UA
R110,R115,R117,R121	4-01455	100	U217	3-00727	LM339
R111,R112,R119,R231,R232, R233	4-01527	100K	U301	3-01424	HDSP-A107
R114,R116,R120	4-01465	270	U302,U303,U304,U305,U306 U307,U308,U309,U310,U311, U312,U313,U314,U315,U316, U317,U318	3-00290	HDSP-A101
R122	4-01510	20K	X101,X102,X103,X104,X105, X106,X107,X108,X109,X110, X111,X112,X201,X202,X203, X204,X205,X206,X207,X208, X209,X210,X211,X212,X213, X214,X215,X216,X217,X218, X219,X220,X221,X222,X223, X224,X225,X226,X301,X302, X303,X304,X305,X306,X307, X308,X309,X310,X311,X312	3-00672	74HC595ADT
			Y101	6-00571	10.000MHz

## 3.2.2 Source Board

Reference	SRS P/N	Part Value	Reference	SRS P/N	Part Value
C401	5-00462	.047U	R502	4-01338	200K
C402,C406	5-00464	.068U	R504	4-01118	1.02K
C403,C407	5-00072	10U	R505	4-01310	102K
C404	5-00466	.1U	R506	4-01214	10.2K
C405,C408	5-00245	1.0U	R507,R528	4-00306	100M
C501,C502,C509,C510	5-00313	1P	R508,R520,R529	4-00139	10.0M
C511,C503	5-00363	10P	R510,R511	4-01023	105
C512,C504	5-00375	100P	R512	4-01654	10.0M
C505,C513	5-00387	1000P	R513	4-01652	1.000M
C506,C514	5-00411	.01U	R514	4-01651	100.0K
C507,C508,C515,C516	5-00411	.1U	R515	4-01650	10.00K
C517	5-00260	470U	R516	4-01649	1.000K
D501,D502	3-00544	BAV70LT1	R517	4-01648	100.0
JP601	1-00406	16 PIN DIL (long)	R518	4-01647	10.00
JP602,JP603	1-00488	2 PIN	R519	4-01646	1.000
K501,K502,K503,K504,K505, K506,K507,K508,K509,K510, K511,K512,K513,K514,K515, K516,K517	3-00308	DS2E-ML2-DC5V	R521	4-00131	1.00M
Q501,Q601,Q602,Q603,Q604, Q605,Q606,Q607,Q608,Q609, Q610,Q611,Q612,Q613,Q614, Q615,Q616,Q617,Q618,Q619, Q620,Q621,Q622,Q623,Q624, Q625,Q626,Q627,Q628,Q629, Q630,Q631,Q632,Q633,Q634	3-00927	MMBT2907ALT1	R522	4-00142	100K
R401,R406,R414,R416,R418, R421	4-01261	31.6K	R523	4-00138	10.0K
R402,R503	4-01242	20.0K	R524	4-00130	1.00K
R403	4-01251	24.9K	R525	4-00141	100
R404	4-01198	6.98K	R526	4-00234	10.0
R405	4-01257	28.7K	R527	4-00800	1.0
R407,R412,R425,R428	4-01209	9.09K	R531	4-01309	100K
R408	4-01146	2.00K	R532	4-01213	10.0K
R409	4-01232	15.8K	R533	4-01117	1.00K
R410,R427	4-01180	4.53K	R535,R534	4-01021	100
R411	4-01260	30.9K	R536	4-00250	2M
R413	4-01102	698	R537	4-00624	500K
R415	4-01050	200	R538	4-00232	50K
R417	4-01006	69.8	R539	4-00240	5.0K
R419	4-00954	20.0	R540	4-00253	500
R420,R423	4-01431	10	R541	4-00342	50
R422	4-00925	10.0	R542,R543	4-00349	10
R426,R424	4-00218	10.00K	R544	4-01479	1.0K
R501,R509,R530	4-01405	1.00M	R545	4-01527	100K
			R546,R601	4-01489	2.7K
			U401	3-01471	OPA2227UA
			U402	3-00670	OPA2277U
			U403	3-01386	DG408
			U501	3-00671	MC34064
			U601	3-00662	74HC14
			U602,U603,U604,U605,U606	3-00787	74HC595
			X401,X402,X403,X404,X405, X406,X601,X602,X603,X604, X605,X606	5-00299	.1U

### 3.2.3 Amplifier Board

Reference	SRS P/N	Part Value	Reference	SRS P/N	Part Value
C701,C704,C711,C716,C719, C721,C723,C724,C727,C733, C738,C742,C743,C746,C810, C811,C813,C815,C816,C817, C827,C828,C830,C832,C833, C834	5-00100	2.2U	R853		
C707,C713,C730,C736	5-00098	10U	R723,R757	4-00983	40.2
C710,C734	5-00363	10P	R724,R725,R758,R759	4-01648	100
C801,C802,C818,C819	5-00372	56P	R760,R727	4-00487	20
C803,C804,C820,C821	5-00382	390P	R730,R763	4-01280	49.9K
C805,C806,C822,C823	5-00450	.0047U	R731,R767	4-01164	3.09K
C807,C808,C824,C825,C901, C902,C903,C904,C905,C906, C907,C908	5-00375	100P	R732,R768	4-01213	10.0K
C809,C826	5-00244	.1U	R801,R802,R828,R829	4-01386	634K
C812,C814,C829,C831	5-00367	22P	R803,R804,R830,R831	4-01338	200K
D702,D705	3-00674	MMBZ5228	R805,R806,R810,R812,R832, R833,R837,R839	4-01242	20.0K
JS901	1-00104	SOCKET 8x2	R834,R807	4-01088	499
JS903,JS902	1-00115	SOCKET 1x2	R808,R809,R835,R836	4-01145	1.96K
JS904	1-00369	DSUB-9 F	R838,R811	4-01076	374
K701,K702	3-00308	DS2E-ML2-DC5V	R813,R814,R840,R841	4-01146	2.00K
L901,L902,L903,L904	6-00174	BEAD/6LEAD	R815,R842	4-01405	1.00M
Q701,Q702	3-01674	LSK389B	R843,R816	4-01064	280
Q901,Q902,Q903,Q904	3-00927	MMBT2907ALT1	R846,R819	4-01052	210
R701,R735	4-01042	165	R848,R821	4-01040	158
R702,R706,R736,R740	4-01021	100	R849,R822	4-01028	118
R737,R703	4-00013	50K	R824,R851	4-01016	88.7
R704,R705,R738,R739	4-00528	499	R854,R827	4-01062	267
R707,R708,R709,R710,R741, R742,R744,R745	4-01309	100K	R901,R902,R903,R904	4-00992	49.9
R711,R733,R743,R766	4-01060	255	U701,U710	3-01398	OPA2131UJ
R714,R715,R750,R751	4-01649	1.000K	U702,U711	3-00998	OPA227UA
R716,R752	4-00954	20	U703,U712	3-00096	LM317L
R718,R728,R748,R762	4-01141	1.78K	U718,U709	3-00100	LM337L
R719,R756	4-00971	30.1	U801,U802,U807,U808	3-01369	DG409
R720,R734,R749,R765,R817, R818,R820,R823,R825,R826, R844,R845,R847,R850,R852,	4-01431	10	U803,U809	3-01386	DG408DY
			U804,U810	3-00133	OPA131
			U805,U806,U811,U812	3-00731	5534
			U901	3-00662	74HC14
			U902,U903,U904	3-00787	74HC595
			X701,X702,X706,X707,X709, X710,X714,X715,X801,X802, X803,X804,X805,X806,X807, X808,X809,X810,X811,X812, X901,X902,X903,X904	5-00299	.1U

### 3.3 Schematic Diagrams

Schematic diagrams follow this page.



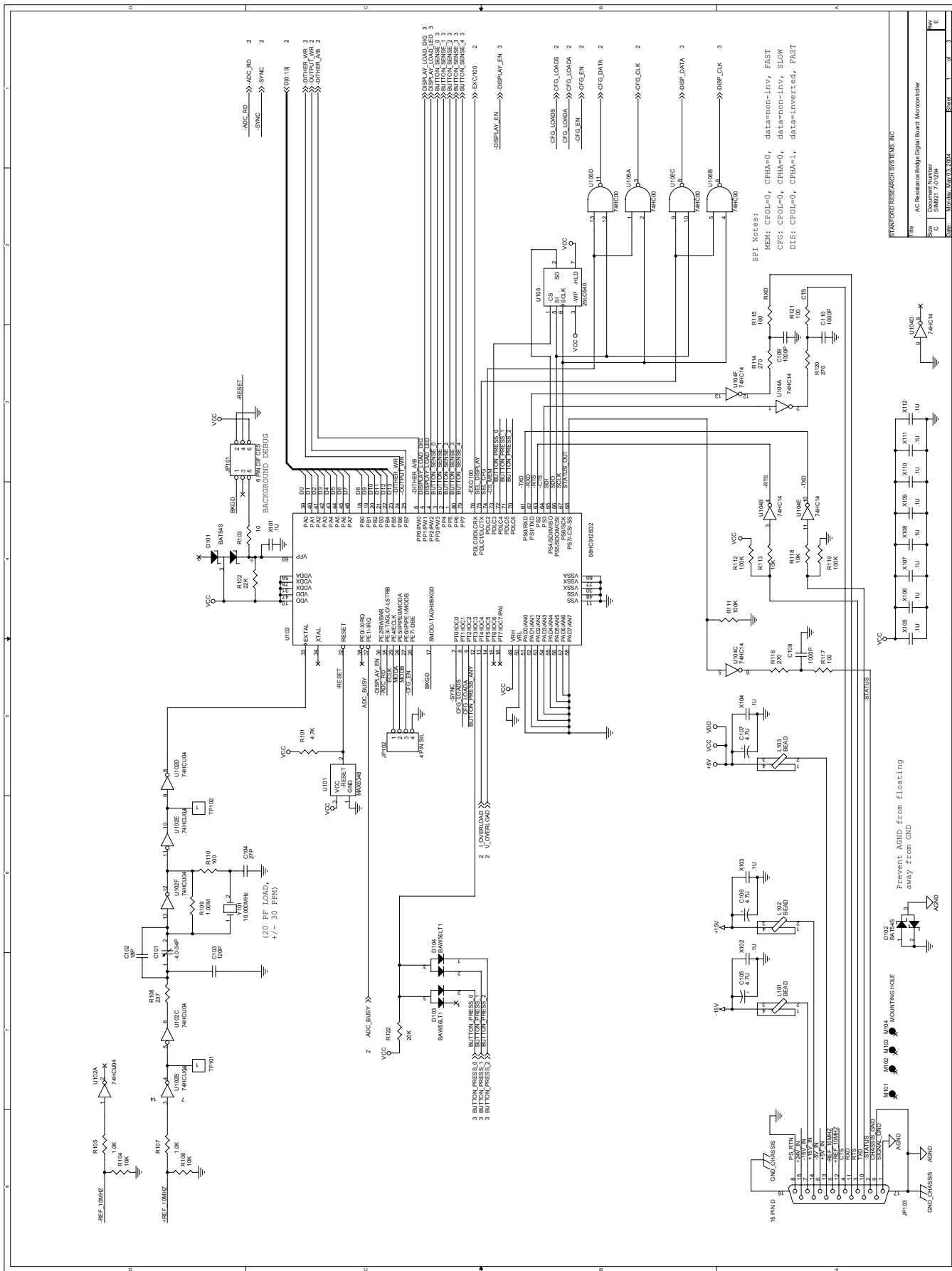

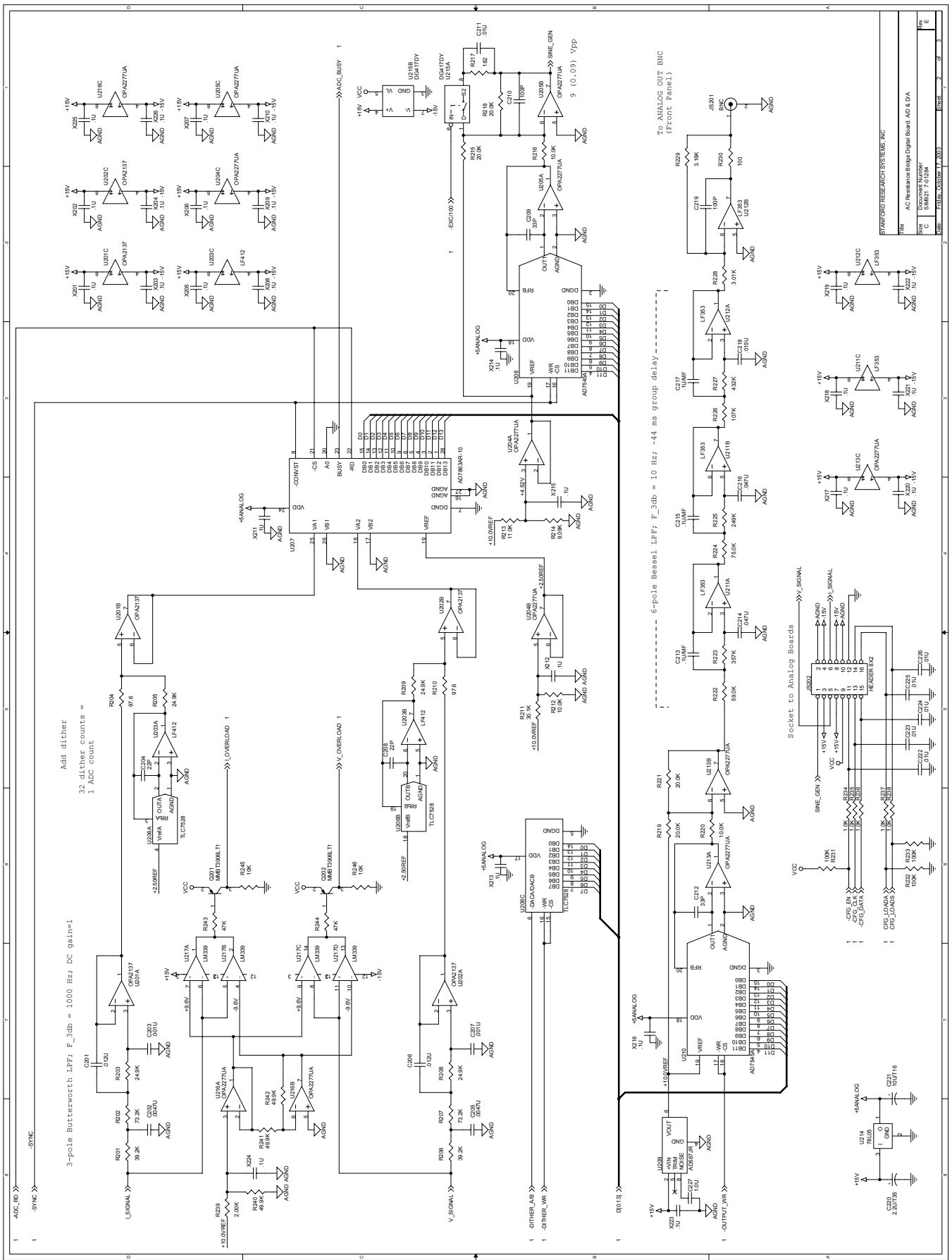

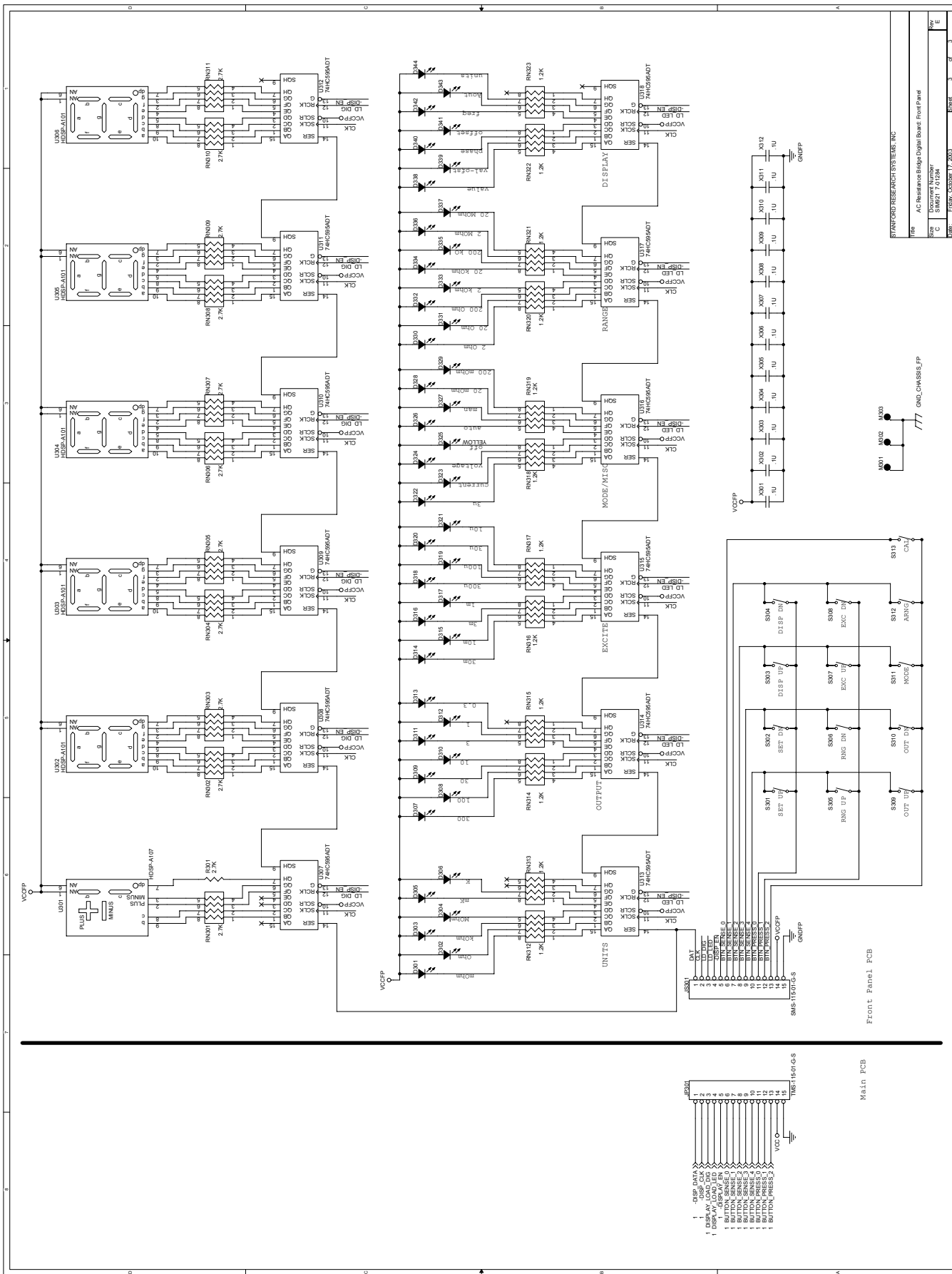

STANFORD RESEARCH SYSTEMS, INC.  
 Title: AC Resonance Bridge Digital Board Front Panel  
 Size: 5.000 X 10.000  
 C: 10/1987  
 Date: 10/1987

4-pole Butterworth LPF  
( $F_{-3dB} = 100$  Hz)

1-pole Highpass  
( $F_{-3dB} = 1.7$  Hz)

Main Gain Group Delay  
of Filter  
F (Hz) | dT (ms)

2.5	33
5.0	14
10.	6.9
15.	5.4
20.	4.9
33.	4.7 (min)

4-pole Butterworth LPF  
( $F_{-3dB} = 100$  Hz)

1-pole Highpass  
( $F_{-3dB} = 1.7$  Hz)

Main Gain Group Delay  
of Filter  
F (Hz) | dT (ms)

2.5	33
5.0	14
10.	6.9
15.	5.4
20.	4.9
33.	4.7 (min)

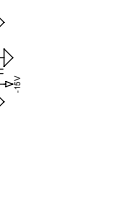
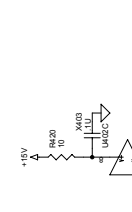
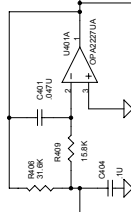
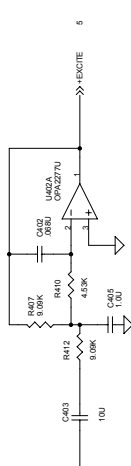
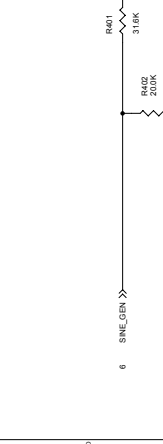

NOTE: Populate with premium (non-A) grade

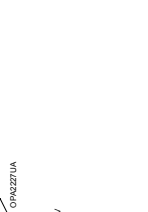
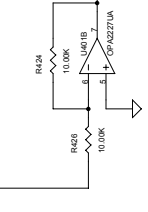
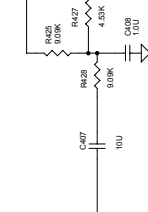
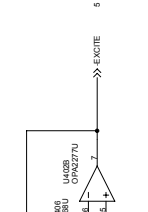
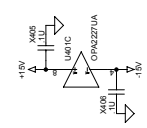

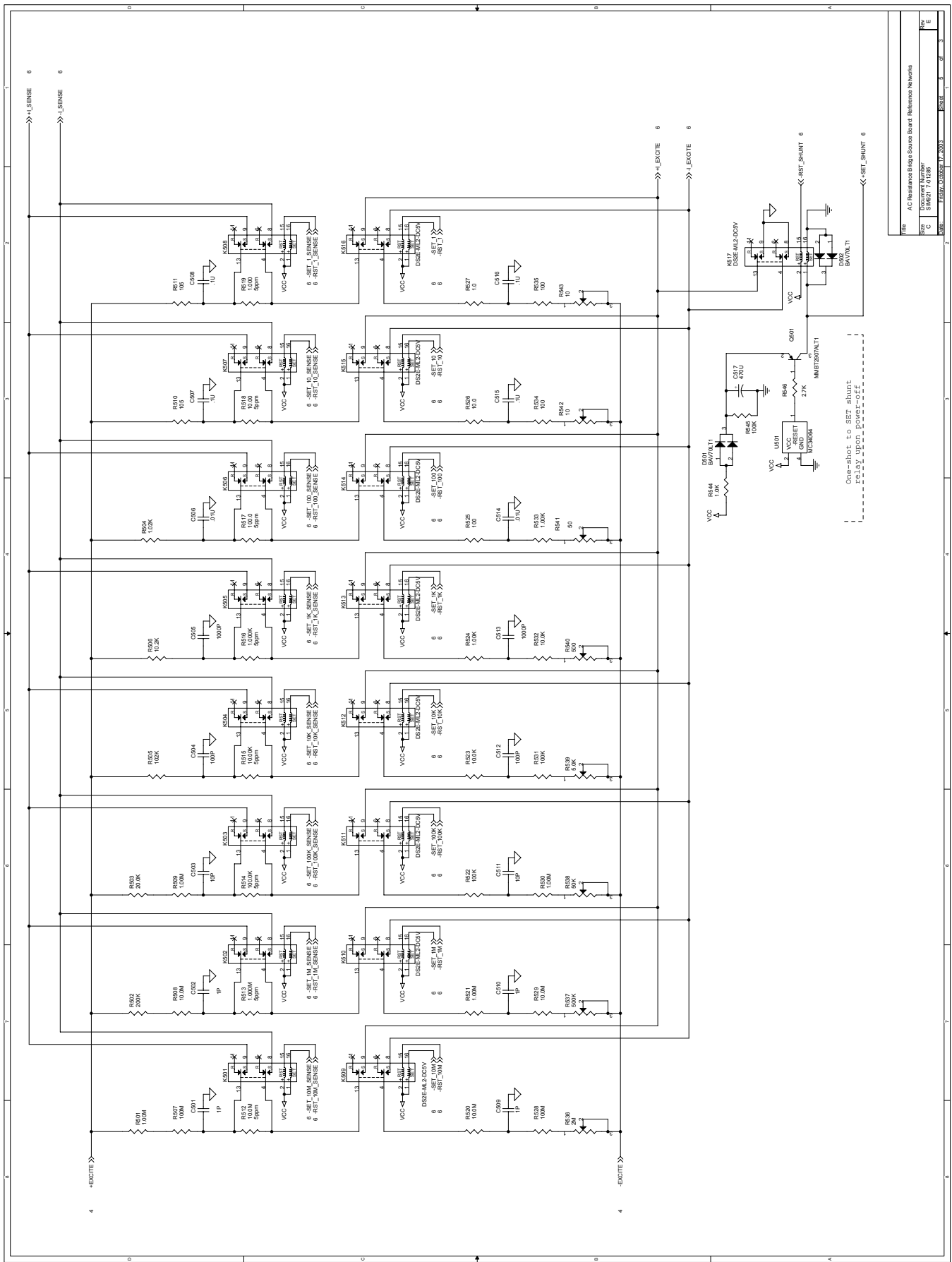

File	AC Reference Bridge Status Board Reference Network
Size	520,000 Bytes
Sheet	5 of 5
Version	1.0

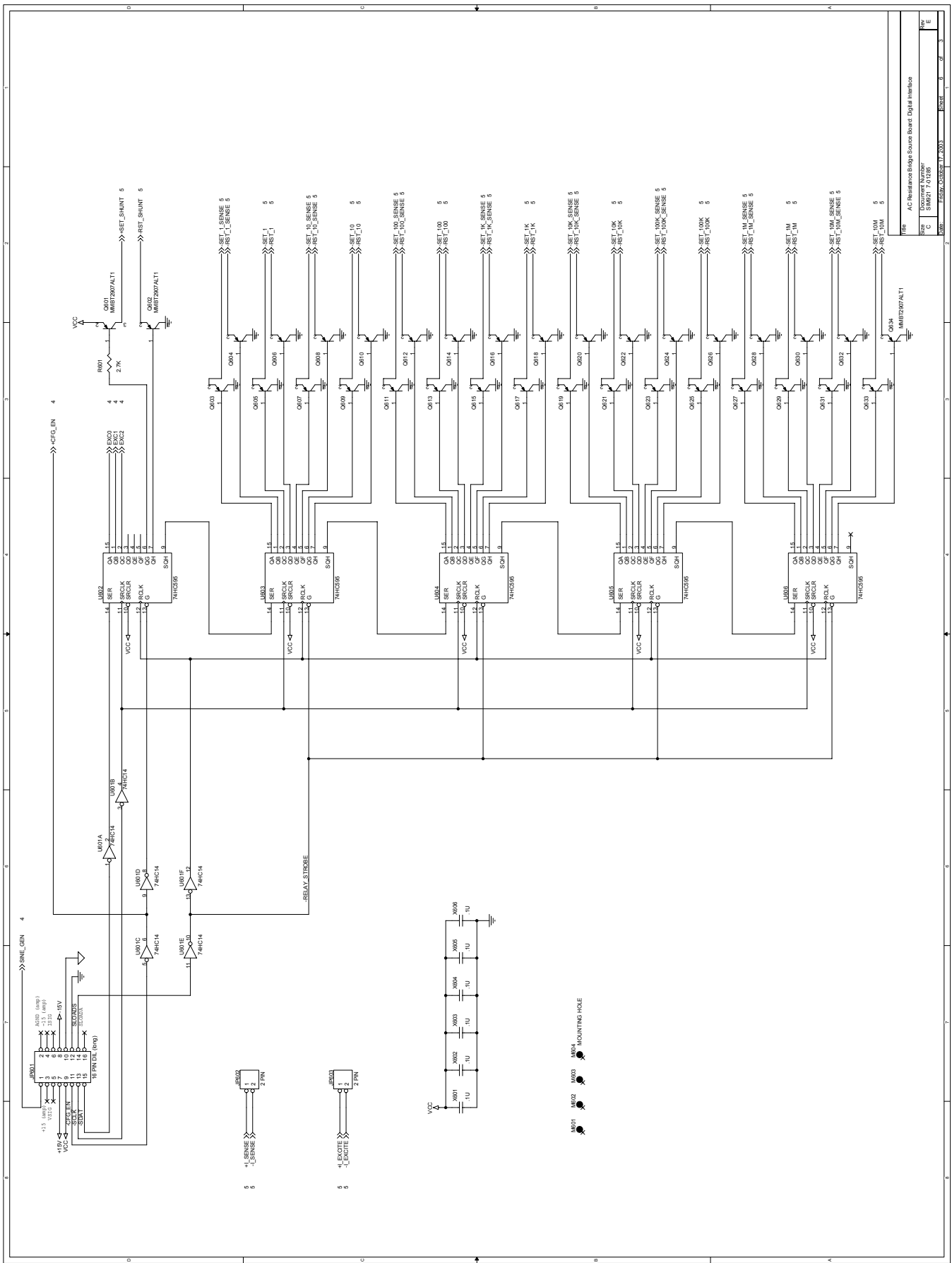

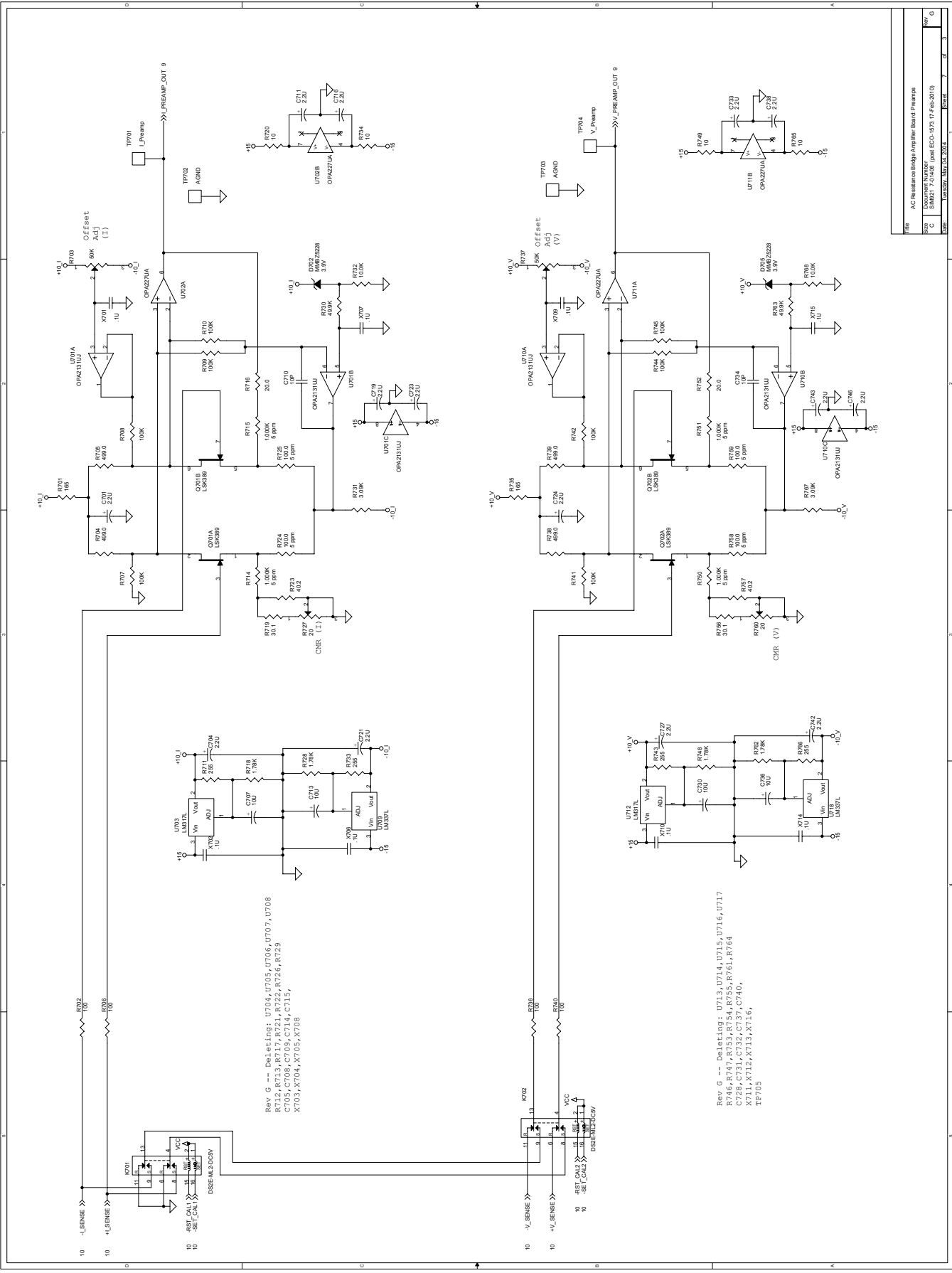

FILE	AC Resonance Bridge Amplifier Board Params
SIZE	550,000 Bytes
DATE	SMT017-01408 (mod ECO-1513 17-Feb-2010)
USER	U01550V_M01_V02
SHEET	7
TOTAL	8

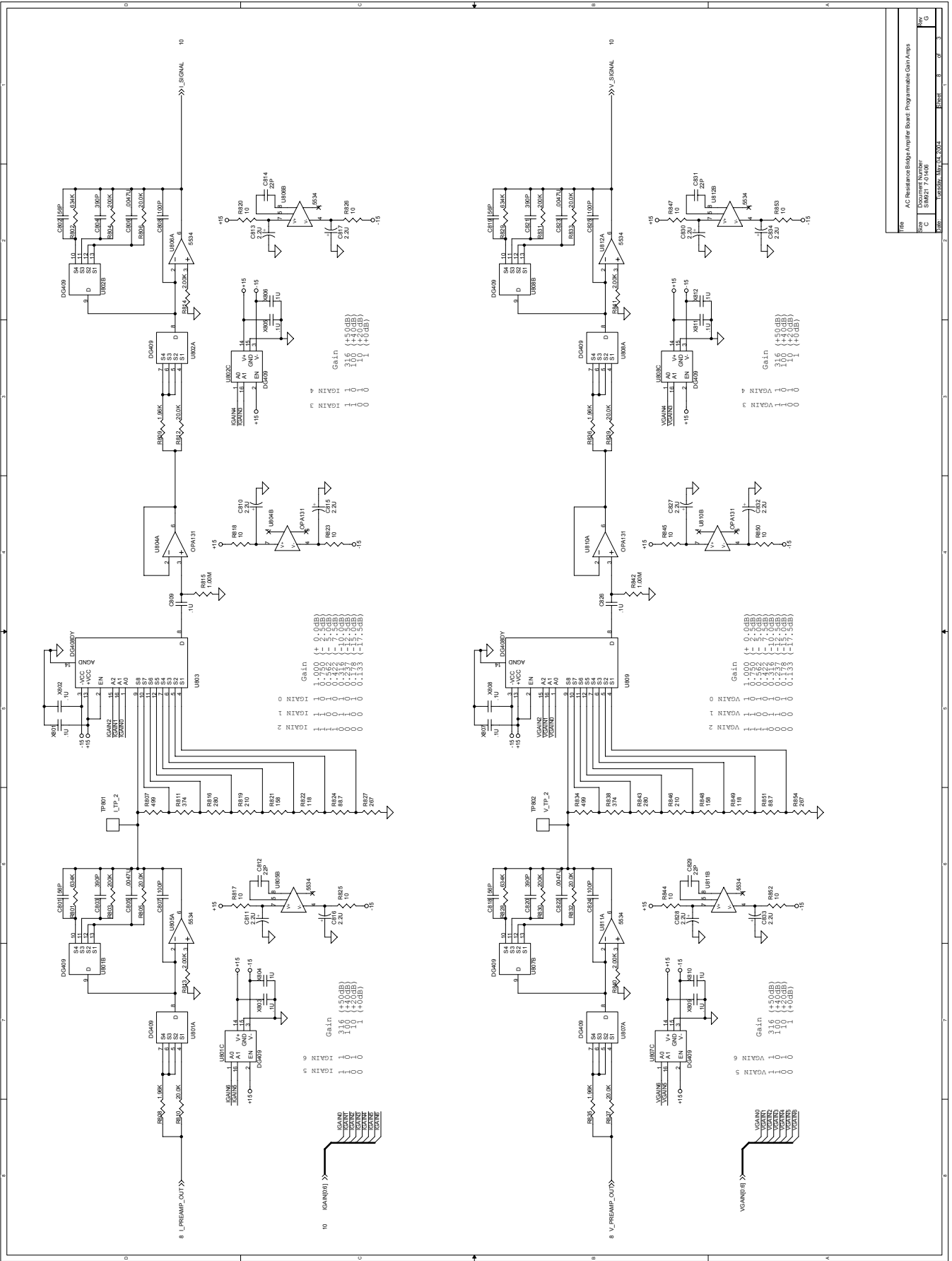

FILE	AC Resonance Bridge Amplifier Board - Programmable Gain Amps
REV	05/20/2005
DESIGNER	SMARIT P. D'ALBINO
DATE	05/20/2005
SCALE	1:1
SHEET	8 OF 8



